

Product Information

- Product Model: S12 Vet
- Product Name: Veterinary monitor
- Manufacturer Name: Guangdong Biolight Meditech Co., Ltd.
- After Service Contact Information:
Address: No.2 Innovation First Road, Technical Innovation Coast, Hi-tech Zone, Zhuhai, P.R. China
Fax: +86-756-3399919
Post code: 519085
Toll-free consultation hot line: +86-400-8818-233

Revision History

This manual has a revision number. This revision number changes whenever the manual is updated due to software or technical specification change. Contents of this manual are subject to change without prior notice.

- Document No.: J/S-I-019
- Revision number: V1.0
- Release time: 2022.04

Copyright © 2022 Guangdong Biolight Meditech Co., Ltd. All rights reserved.

Statement

Guangdong Biolight Meditech Co., Ltd. (hereinafter called Biolight) holds the copyright of this manual, and we are also entitled to deal with this manual as confidential files. This manual is only used for operation, maintenance and service of product, someone else can not publish the manual.

This manual contains exclusive information protected by copyright laws and we reserve its copyright. Without written approval of manufacturer no parts of this manual shall be photocopied, Xeroxed or translated into other languages.

The contents contained in this manual are subject to amendments without notification.

Manufacturer's Responsibility

Only under the following circumstances will manufacturer be responsible for the safety, reliability and performance of the instrument:

- All the installation, expansion, readjustment, renovation or repairs are conducted by the personnel certified by manufacturer.
- All the replaced components, assorted accessories and consumables involved in maintenance are original or approved by Biolight.
- The storage condition, operation condition and electrical status of the instrument conform to the product specification. The electrical installation of the relevant room complies with the applicable national and local requirements;
- The instrument is used in accordance with the user's manual.

Signs in this manual:



WARNING: Indicates a potential hazard or unsafe practice that, if not avoided, will result in death or serious injury.



CAUTION: Indicates a potential hazard or unsafe practice that, if not avoided, could result in minor injury or product/property damage.



NOTE: Provides application tips or other useful information to ensure that you get the most from your product.

Warranty and maintenance service

The warranty period for the purchased products shall be subject to the sales contract. The consumables means disposable consumables material needed to be replaced after using every time or vulnerable material needed to be replaced regularly. The consumables don't have warranty service.

The warranty period starts from the "installation date" filled in on the attached **<Equipment Warranty Card>**, which is the only proof to calculate the warranty period.

In order to protect your rights, please fill in the warranty card after the installation of the equipment, and give the second warranty card ("Biolight company retention") to the installer or mail it back to the after-service department of Biolight.

Please note that the following conditions will not be covered by the warranty:

- ⇒ The customer does not fill in or return the equipment warranty card within 30 days after the installation acceptance;
- ⇒ The equipment series number provided by the customer is not correct (our company confirms the equipment series number is warranty or not).

Within the warranty period, all products can enjoy free after-sales service; however, please note that, even within the warranty period, due to the following reasons, the products need to be repaired, the company will carry out maintenance service, you need to pay maintenance fees and accessories fees:

- ⇒ Man-made damage;
- ⇒ Improper use;
- ⇒ The voltage of the power network exceeds the product's specified range;
- ⇒ Irresistible natural disasters;
- ⇒ Replace or use parts, accessories, consumables that are not approved by Biolight or maintained by non-authorized personnel of Biolight;
- ⇒ Other faults not caused by the product itself.

After the expiration of the warranty, Biolight can continue to provide charged maintenance services. If you do not pay or delay in paying the maintenance fee, Biolight will suspend the maintenance service until you pay for it.

After service

Manufacturer:	Guangdong Biolight Meditech Co., Ltd.
Address:	No.2 Innovation First Road, Technical Innovation Coast, Hi-tech Zone, Zhuhai, P.R. China
Fax:	+86-756-3399919
Post code:	519085
Toll-free consultation hot line:	+86-400-8818-233

About this manual

This manual contains the instructions necessary to operate the product safely and in accordance with its function and intended use. Observance of this manual is a prerequisite for proper product performance and correct operation and ensures patient and operator safety.

This manual is based on the maximum configuration and therefore some contents may not apply to your product. If you have any question, please contact us.

This manual is an integral part of the product. It should always be kept close to the equipment so that it can be obtained conveniently when needed.

The manual is geared for clinical professionals who are expected to have a working knowledge of medical procedures, practiced and terminology as required for monitoring patients.

All illustrations in this manual serve as examples only. They may not necessarily reflect the setup or data displayed on your product.

Conventions:

- ◆ ***Bold Italic*** text is used in this manual to quote the referenced chapter or sections.
- ◆ **【】** is used to enclose screen texts.
- ◆ → is used to indicate operational procedures.

Content

Chapter 1 General Introduction	1-1
1.1. Intended Use	1-1
1.2. Main Unit	1-1
1.3. Screen Display	1-5
Chapter 2 Safety.....	2-1
2.1. Safety Information	2-1
2.2. Equipment Symbols	2-3
2.3. Packaging Symbols	2-4
Chapter 3 Basic Operations	3-1
3.1. Installation.....	3-1
3.2. Getting Started	3-3
3.3. Shutting off the Monitor.....	3-4
3.4. Operation and Browse.....	3-5
3.5. General Settings	3-6
3.6. Measurement Settings	3-8
3.7. Operation Mode	3-10
3.8. Using the Timer.....	3-14
3.9. Voice Assistant.....	3-15
Chapter 4 Patient Management	4-1
4.1. Discharging a Patient	4-1
4.2. Admitting a Patient	4-2
4.3. Managing Patient Information.....	4-2
4.4. Connecting to a Central Monitoring System	4-4
Chapter 5 Managing Configurations.....	5-1
5.1. Introduction.....	5-1
5.2. Selecting default configuration.....	5-1
5.3. Saving current settings	5-1
5.4. Deleting a configuration.....	5-2
5.5. Transferring a configuration.....	5-2
5.6. Loading current configuration.....	5-3
5.7. New Patient Usage Configuration	5-3
5.8. Monitor Boot Usage Configuration.....	5-4
5.9. Setting password valid time	5-4
Chapter 6 User Interface.....	6-1
6.1. Interface Style	6-1
6.2. Dynamic Trend Screen.....	6-2
6.3. OxyCRG screen	6-3
6.4. Other Bed Observation.....	6-4
6.5. Big Font Screen.....	6-8

6.6. Freezing Waveforms	6-8
Chapter 7 Alarm	7-1
7.1. Introduction.....	7-1
7.2. Safety Information	7-1
7.3. About the alarm.....	7-2
7.4. Viewing physiological alarms list	7-4
7.5. Viewing technical alarms list	7-4
7.6. Setting Alarm.....	7-4
7.7. Alarm Pause.....	7-9
7.8. Alarm Reset.....	7-11
7.9. Latching Alarms.....	7-11
7.10. Nurse Call	7-12
7.11. Intubation Status.....	7-14
7.12. Other Bed Alarm	7-15
7.13. Detecting Alarm	7-16
7.14. Actions When an Alarm Occurs.....	7-16
Chapter 8 ECG.....	8-1
8.1. Introduction.....	8-1
8.2. Safety Information	8-1
8.3. ECG Display	8-2
8.4. Preparing for ECG Monitoring.....	8-3
8.5. ECG Settings.....	8-9
8.6. Arrhythmia Monitoring	8-15
8.7. ST Monitoring.....	8-17
8.8. QT/QTc Monitoring.....	8-24
8.9. Isoelectric Segments.....	8-29
8.10. ECG Relearning	8-29
8.11. Calibrating ECG.....	8-29
8.12. Defibrillation Synchronization	8-30
8.13. ECG Troubleshooting	8-31
Chapter 9 Respiration Rate (RESP).....	9-1
9.1. Introduction.....	9-1
9.2. Safety Information	9-1
9.3. RESP Display.....	9-2
9.4. Placing RESP Electrodes	9-2
9.5. RESP Settings	9-4
9.6. RESP Troubleshooting.....	9-6
Chapter 10 SpO2.....	10-1
10.1. Introduction	10-1
10.2. Safety Information	10-2
10.3. Monitoring Procedure	10-3
10.4. Setting SpO2	10-3
10.5. Setting PR	10-5
10.6. SpO2 Measurement Limitations.....	10-6

Chapter 11 Temperature (TEMP)	11-1
11.1. Introduction	11-1
11.2. Displaying the TEMP Parameter Area	11-1
11.3. TEMP Display	11-1
11.4. Preparing for TEMP Monitoring	11-2
11.5. TEMP Settings	11-2
11.6. TEMP Troubleshooting	11-3
Chapter 12 NIBP	12-1
12.1. Introduction	12-1
12.2. Safety Information	12-1
12.3. NIBP Measurement Limitations	12-3
12.4. Measurement Modes	12-3
12.5. NIBP Display	12-4
12.6. Preparing for NIBP Measurements	12-5
12.7. Starting and Stopping NIBP Measurements	12-7
12.8. NIBP Settings.....	12-8
12.9. Assisting Venous Puncture.....	12-10
12.10. NIBP Maintenance	12-11
12.11. NIBP Troubleshooting	12-11
Chapter 13 IBP	13-1
13.1. Introduction	13-1
13.2. Safety information.....	13-1
13.3. IBP measurement	13-2
13.4. IBP Display	13-3
13.5. Setting IBP	13-5
13.6. IBP troubleshooting.....	13-9
Chapter 14 Cardiac output (C.O.)	14-1
14.1. Introduction	14-1
14.2. Safety Information	14-1
14.3. C.O. Measurement Limitation	14-1
14.4. C.O. Display.....	14-2
14.5. C.O. Equipment Connecting	14-3
14.6. C.O. Measurement.....	14-3
14.7. C.O. Setting.....	14-6
14.8. C.O. Troubleshooting	14-7
Chapter 15 Carbon Dioxide (CO₂)	15-1
15.1. Introduction	15-1
15.2. Safety information.....	15-1
15.3. CO ₂ Measurement Limitations	15-2
15.4. Monitoring Procedure	15-2
15.5. Display	15-7
15.6. Settings CO ₂	15-8
15.7. Entering Intubation Status	15-11
15.8. Zeroing.....	15-11

15.9. Calibration.....	15-12
15.10. Exhaust Emission	15-13
15.11. Announcements	15-13
15.12. CO ₂ Troubleshooting.....	15-15
Chapter 16 Drip Monitor (DM).....	16-1
16.1. Introduction.....	16-1
16.2. Safety information.....	16-1
16.3. DM measurement.....	16-2
16.4. DM module indicator	16-5
16.5. DM display.....	16-5
16.6. Setting DM.....	16-6
16.7. DM check.....	16-6
Chapter 17 Review.....	17-1
17.1. Review Overview.....	17-1
17.2. Reviewing Page.....	17-1
Chapter 18 Calculations	18-1
18.1. Introduction.....	18-1
18.2. Safety information.....	18-1
18.3. Drug Calculation	18-1
18.4. Hemodynamic Calculations	18-4
18.5. Oxygenation Calculation.....	18-6
18.6. Ventilation Calculations.....	18-9
18.7. Nephridium Calculation	18-11
Chapter 19 Recording.....	19-1
19.1. Recorder.....	19-1
19.2. Recording Type.....	19-1
19.3. Starting Recordings.....	19-2
19.4. Stopping Recordings	19-2
19.5. Recording Flags	19-2
19.6. Setting the Recorder.....	19-3
19.7. Installing Recording Paper	19-4
19.8. Clearing Jam Paper.....	19-5
19.9. Cleaning Recorder.....	19-5
Chapter 20 Other Functions.....	20-1
20.1. Analog Signal Output.....	20-1
20.2. Network Settings	20-1
20.3. HL7 Settings	20-4
Chapter 21 Battery	21-1
21.1. Introduction.....	21-1
21.2. Installing a Battery	21-1
21.3. Battery Guidelines.....	21-1
21.4. Battery Maintenance	21-2
21.5. Battery Recycling.....	21-4

Chapter 22 Maintenance and Cleaning	22-1
22.1. Introduction	22-1
22.2. Cleaning of the Monitor	22-2
22.3. Disinfection	22-2
22.4. Cleaning and Sterilizing of Accessories	22-3
22.5. Sterilization	22-4
Chapter 23 Maintenance	23-1
23.1. Inspection	23-1
23.2. Maintenance Schedule	23-2
23.3. Disposing of the Monitor	23-3
Chapter 24 Accessories	24-1
24.1. Recommended Accessories	24-2
Appendix A Product Specifications	1
A.1 Safety Specifications	1
A.2 Environmental Specifications	2
A.3 Physical Specifications	2
A.4 Power Specifications	3
A.5 Hardware Specifications	4
A.6 Data Storage	7
A.7 Wireless network	7
A.8 Measurement Specifications	8
A.9 Alarm Specification	25
Appendix B EMC and Radio Regulatory Compliance	28
B.1 EMC	28
B.2 The management compliance of Radio	34
Appendix C Default Settings	35
C.1 ECG, Arrhythmia, ST, QT	35
C.2 RESP	38
C.3 SpO2	38
C.4 TEMP	39
C.5 NIBP	40
C.6 IBP	41
C.7 C.O.	43
C.8 CO2	43
C.9 DM	44
C.10 Alarm Default Settings	44
C.11 Screen Setup	45
C.12 Color of parameters	45
C.13 Recorder	45
C.14 Other	46
C.15 Maintenance Item	46
Appendix D Alarm Message	48

D.1 Physiological alarm	48
D.2 Technical Alarm.....	50
Appendix E Cybersecurity	60
E.1 Operating environment	60
E.2 Network data interface.....	60
E.3 User access control mechanism	60
E.4 Software Environment	61
Appendix F Terminology and Definitions	62
F.1 List of units	62
F.2 Symbol list.....	63
F.3 Terminology list.....	64
Appendix G Toxic and Harmful Substances or elements	68

Chapter 1 General Introduction

1.1. Intended Use

The Veterinary monitor, hereafter called the monitor, are intended to be used for monitoring, displaying, reviewing, storing and alarming of multiple physiological parameters of animals, including ECG, Heart Rate(HR), Respiration Rate(RR), Temperature(TEMP), Pulse Oxygen Saturation(SpO₂), Pulse Rate(PR), Non-invasive Blood Pressure(NIBP), Carbon dioxide(CO₂), Invasive Blood Pressure(IBP) and Cardiac output(C.O.).



WARNING:

- **The monitor is intended for use only by clinical professionals or under their guidance. It must only be used by persons who have received adequate training in its use. Anyone unauthorized or untrained must not perform any operations on it.**
-

1.2. Main Unit

1.2.1. Front View

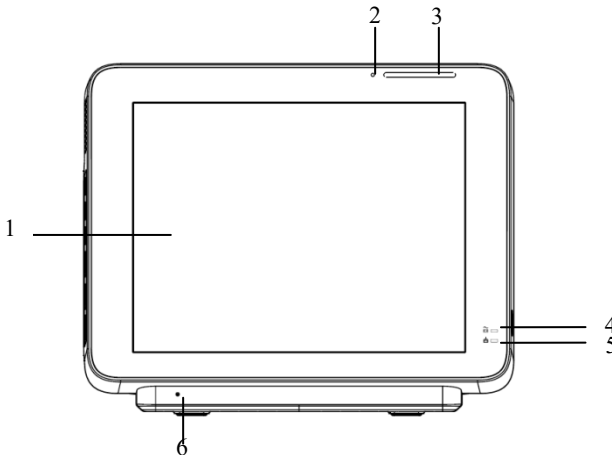

1. Display screen
2. Light induction: For example, when the environment is dark, the display brightness can be automatically adjusted.
3. Alarm lamp
Alarm lamp with different color and flashing frequency indicates the level of technical alarm and physiological alarm:
 - ◆ High level alarm: the lamp quickly flashes red.
 - ◆ Medium level alarm: the lamp slowly flashes yellow.
 - ◆ Low level alarm: the lamp lights cyan without flashing.
4. Power indicating lamp
It is a LED that lights green and orange, the status of the LED is specified as follows:
 - ◆ Green: When the AC mains is connected.
 - ◆ Orange: When the AC mains is not connected and monitor is powered by battery.
 - ◆ Off: When the AC mains is not connected.
5. Charging indicating lamp
 - ◆ Light up: When the battery is being charged.
 - ◆ Off: When the battery is fully charged or no battery in monitor.
6. Phonetic holes.

1.2.2. Side View

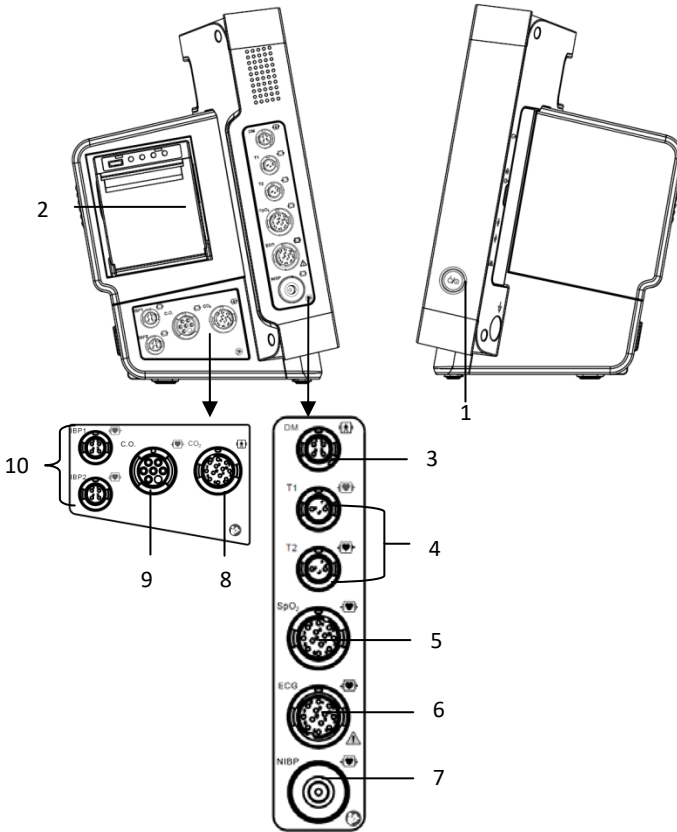

1. Power button

Power on: after the monitor is connected to the AC power supply, press the button to open the monitor.

Power off: in the startup state, short or long press the power switch button to turn off the monitor

2. Recorder

3. DM connector

4. TEMP connector

5. SpO2 connector

6. ECG connector

7. NIBP connector
8. CO2 connector
9. C.O. connector
10. IBP connector

1.2.3. Rear View

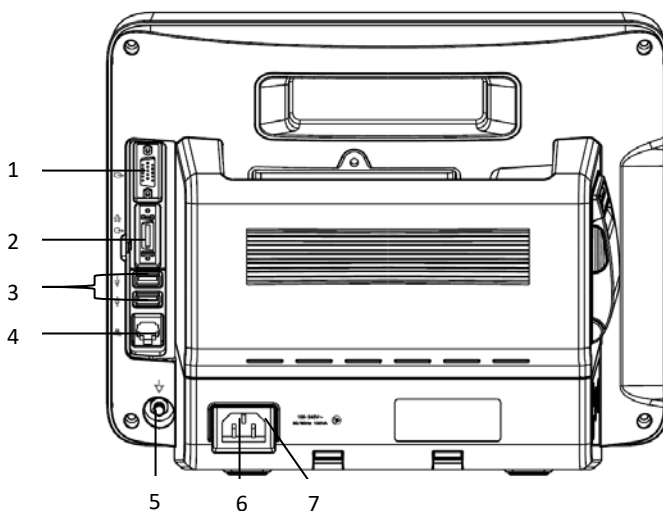

1. VGA connector (optional)

Connect secondary display with a standard VGA connector. Auxiliary display and monitoring are performed by connecting a secondary display. The display content of the secondary display is consistent with the monitor display.

2. Multifunction connector (optional)

Simultaneously output defibrillation synchronization signal, nurse call signal and analog output signal.

3. USB connector

It includes 2 standard USB2.0 connectors, which can be connected to USB devices such as U disk and barcode scanner.

4. Network connector

The standard RJ45 interface, enabling networking with the central monitoring system,

other bed communications and system upgrades via.

5. Equipotential grounding terminal

When other devices and monitors are unified used, the wires should be used to connect the equipotential grounding terminal of other devices and monitors to eliminate the potential difference between different devices and ensure safety

6. AC power socket

7. Cable retainer

1.3. Screen Display

The monitor adopts a display screen of high-resolution TFT LCD. Measurement parameters, waveforms, patient information, alarm area and menu can be displayed on the screen. Standard screen is shown as follows:

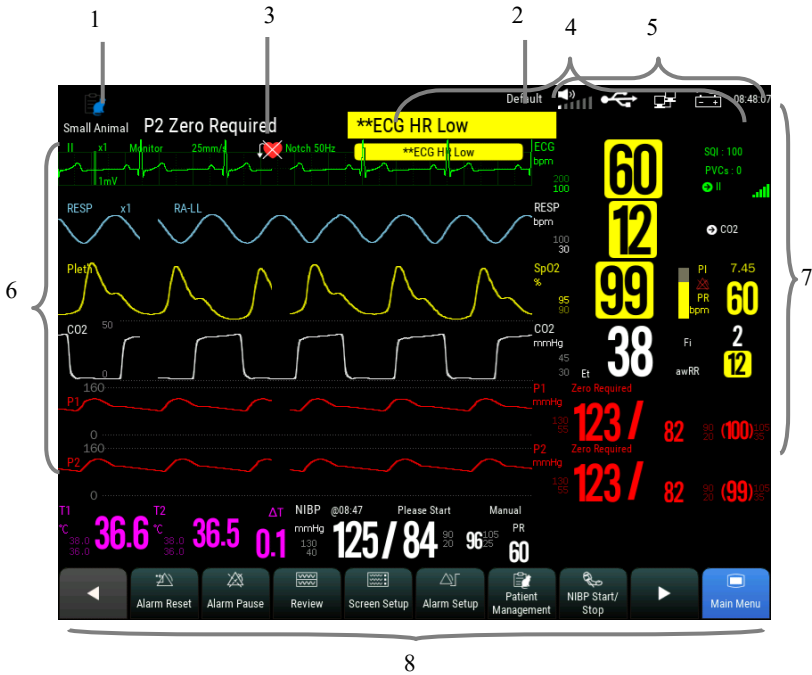

1. Patient info area

Shows the room number, bed number, patient name, patient category and so on.

Select this area to enter the **【Patient Management】** menu and detailed description please to refer *Chapter 4 Patient Management*.

2. Current configuration

3. Technical alarm area

Display technical alarm information and prompt information. Cyclic displaying when there are multiple messages. Select this area to open the **【Alarm Informations】** menu to view the current technical alarm.

4. Physiological alarm area

Shows the physiological alarm messages, medium-level and low-level alarm messages display on the left, while the high-level alarm messages display on the right. Cyclic displaying when there are multiple messages. Select this area to open the **【Alarm Informations】** menu to view the current physiological alarm.

5. System status information area

Display alarm volume, network and storage devices connection status, battery and system time. For the battery status icon please to refer *chapter 21 Battery*.

6. Waveform area

Show the waveforms of physiological parameter. Label displays on the top left corner of each waveform area. Select the waveform area of a parameter and enter the corresponding parameter setting menu.

7. Parameter area















It consists of various parameter areas, and shows parameter value, unit, alarm limit and alarm status, etc. Label displays on the top left corner of each parameter area. Select the parameter area of a parameter to enter the corresponding parameter setting menu.

8. Area of touch quick keys

Shows quick keys, these quick keys are used to conduct some common operations.

1.3.1. Interface Symbols

The following table shows the symbols and meanings displayed in the system information area:















Symbol	Note	Symbol	Note
	Wireless network connected. The physical part represents the network signal strength.		Wireless network not connected.
	Wired network connected		Wired network not connected.
	All the alarms are paused.		The parameter alarm is turned off or the alarm system of the monitor is turned off.
	The alarm has been confirmed and the alarm system has been reset.		Audible alarm tones are turned off
	Indicates that the battery is fully charged.		Indicates that the battery is half charged.
	Indicates that the battery is empty and needs to be charged.		Indicates that the battery is almost depleted and need to be charged immediately, otherwise the monitor will automatically turn off.
	Indicates that the battery is being charged.		Indicates that the monitor is being powered by AC power.
	No battery is installed.		















1.3.2. Quick keys

Quick keys are displayed at the bottom of the monitor's main screen. Through the quick keys, you can easily and quickly access some functions or perform operations.

1.3.2.1. Quick keys list

The symbols on the quick keys are shown as follows:

Symbol	Quick key Note	Function
	Previous page	Previous page
	Next page	Next page
	Main menu	Enter the main menu
	Standby	Enter the Standby mode
	Alarm Setup	Enter the 【Alarm Setup】 menu
	Review	Enter the 【Review】 interface
	NIBP measure	Enter the 【NIBP Measure】 menu
	NIBP Start/ Stop	Start/Stop NIBP measurement
	NIBP Stop All	Stop all NIBP measurement
	NIBP STAT	NIBP STAT measurement mode
	Venipuncture	Start/Stop Assistant venipuncture
	Zero	Start IBP, CO2 Zero
	Freeze	Enter the 【Freeze】 menu
	Alarm Reset	Alarm reset
	Alarm Pause	Pause current alarm
	Screen setup	Enter the 【Screen Setup】 menu

Symbol	Quick key Note	Function
	Patient Management	Enter the 【Patient Management】 menu
	Discharge patient	Discharge the current patient
	Sound	Enter the 【Sound】 setting menu
	Brightness	Enter the 【Brightness】 menu
	Lock screen / Unlock screen	Disable/activate touch screen
	Wireless Setup	Enter the 【Wireless Setup】 menu
	Intubation status	Enter / exit Intubation status
	Record setup	Enter the 【Record Setup】 menu
	Realtime Record	Manually start/stop real-time recording
	Calculations	Enter the 【Calculations】 menu
	Remote View	Enter the 【Remote View】 interface
	Night mode / exit night mode	Enter / Exit night mode
	Voice Assistant / Turn off voice assistant	Turn voice assistant on/off
	Manual event	Manually trigger and save events

1.3.2.2. Setting the quick keys

You can set quick keys which need to be displayed on the interface, as follows:

1. Enter the **【Quick keys】** setting menu in one of the following ways:
 - Select **【Screen Setup】** quick key → select **【Quick keys】** submenu.

- Select the **【Main Menu】** quick key → select **【Quick keys】** from **【Display】** column.
2. Set the required quick keys:
- Add quick key: Select desired quick key from the **【Choices】** column on the left, and then select **【Add】** .
 - Delete parameters: Select desired quick key from the **【Selected】**column on the right, and then select **【Delete】** .
 - Move the display position of quick key: From the **【Selected】**quick key column on the right to select quick keys needed to be moved. And select **【Move To Up】**, **【Move To Down】**, **【Move To Top】** or **【Move To Bottom】** as needed.
 - Select **【Default Setting】** and the quick key settings will restore the factory default settings.

1.3.3. Menu

The styles of the various menus are basically similar, see the picture below:

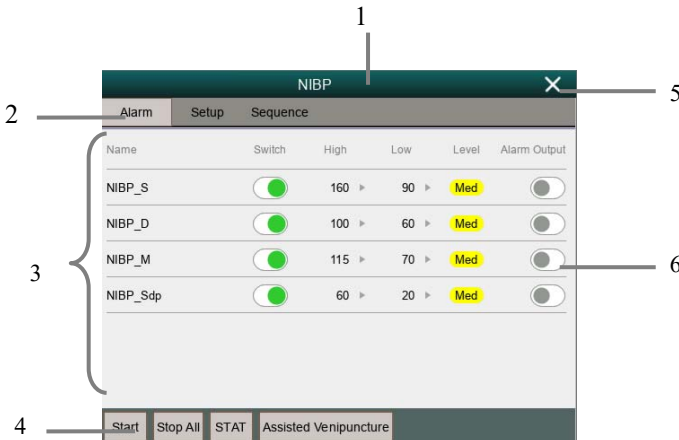

1. Menu title: Summary of the current menu.
2. Submenu button: Press this button to enter the corresponding submenu.
3. Main display area of menu: Display menu options.

4. Operation button: Click to start an operation.
5. Exit button: Exit the current menu.
6. Function switch:
 - Green: The function switch is on;
 - Gray: The function switch is off.

Chapter 2 Safety

2.1. Safety Information



WARNING:

- The device is intended for animal monitoring by trained personnel in the specified places.
- The physiological data and alarm messages displayed on the monitor are for reference only and cannot be directly used for diagnostic interpretation.
- The monitor can only be used for a single patient at the same time
- This monitor can only be connected to a power outlet that has a protective ground. Do not use a removable multi-hole socket. If the power outlet is not connected to a grounding conductor, do not use the outlet and use a rechargeable battery to power the monitor.
- Before use, you must check the equipment, cables and accessories to ensure they work properly and safely.
- To avoid explosion hazard, do not use the monitor in the presence of flammable anesthetics or other flammable substance in combination with air, oxygen-enriched environments, or nitrous oxide.
- Do not open the shell of the device; otherwise the electric shock hazard may exist. All maintenance and upgrades must be carried out by the personnel trained and authorized by manufacturer only.
- Do not use the monitor in nuclear magnetic resonance (MR) environments.
- The operator cannot simultaneously touch the conductive parts on the patient and the monitor.
- Do not come into contact with the patient during defibrillation. Otherwise serious injury or death could result.
- Do not rely exclusively on the audible alarm system for patient monitoring. Adjustment of alarm volume to a low level or off may result in a hazard to the patient. Remember that alarm settings should be customized according to different patient situations and always keeping the patient under close

surveillance is the most reliable way for safe patient monitoring.

- Carefully place the power cord and various accessory cables to avoid risk of entanglement or suffocated, the cables entangled, or subject to electrical interference.
 - To avoid danger or pollute the environment, the packaging materials must be handled in accordance with local regulations or the hospital's waste disposal system. Packaging materials must be placed out of reach of children.
 - When monitoring the patient, the monitor should be continuously powered. Unexpected power interruption of the monitor may result in loss of patient data.
 - The user should periodically check and move the sensor on the skin to avoid adverse skin or tissue effects.
-



CAUTION:

- To ensure patient safety, use only parts and accessories specified in this manual.
- Magnetic and electrical fields are capable of interfering with the proper performance of the monitor. For this reason make sure that all external devices operated in the vicinity of the monitor comply with the relevant EMC requirements. Mobile phone, X-ray equipment or MRI devices are a possible source of interference as they may emit higher levels of electromagnetic radiation.
- To avoid contamination or infection of personnel, environment or other equipments, the equipment and its accessories that meet the service life must be disposed in accordance with relevant local regulations or hospital systems.
- The lifetime of the monitor is 5 years.
- Before turning on the device, make sure that the voltage and frequency of the power supply meet the label of the device or the requirements specified in this manual.
- Please install or carry the equipment properly to prevent it from falling, colliding, being subjected to strong vibration or other mechanical external damage.

- The monitor must be wiped dry immediately after exposure to rain or splashes.
- Please do not mix different types and brands of electrodes. Mixing the electrodes may result in a large baseline drift or a long baseline recovery time after defibrillation. It is forbidden to use dissimilar metal electrodes, which may cause high polarization voltages.

















NOTE:

- Put the monitor in a location where you can easily see the screen and access the operating controls.
- This device uses a power plug to disconnect it from an AC power. Place the device in a location where it is easy to plug in and out.
- In normal use, the operator should stand in front of the device
- Keep this manual near the device so that it can be easily and timely obtained when needed.
- This manual describes the product in the most complete configuration. This manual describes all features and options. Your monitor may not have all of them.





2.2. Equipment Symbols

Your device may not have all of the symbols below.

Symbol	Note	Symbol	Note
	Defibrillation-proof Type BF applied part	ECG	Abbreviation of "Electrocardiogram".
	Defibrillation-proof Type CF applied part	SpO₂	Abbreviation of Pulse "Oxygen Saturation".
	Attention: Consult accompanying documents (this manual).	TEMP	Abbreviation of "Temperature".
	Non-ionizing radiation	CO₂	Abbreviation of "Carbon dioxide".
	Dangerous voltage	NIBP	Abbreviation of "Non-invasive Blood Pressure".

Symbol	Note	Symbol	Note
	Equipotential grounding	IBP	Abbreviation of "Invasive Blood Pressure".
	Auxiliary output	DM	Abbreviation of "Drip Monitor".
	Network	C.O.	Abbreviation of "Cardiac output"
	VGA display connector		Alternating current (AC)
	USB		Defibrillator synchronization output connector
	Manufacture date		Manufacturer
	Serial number	IP21	Degree of protection against ingress of liquid
	Refer to this user's manual.		Batch code
	Warning: the protection against the effects of the discharge of a cardiac defibrillator is dependent upon the appropriated cable		
	Symbol for the marking of electrical and electronics devices according to Waste Electrical and Electronic Equipment Directive.		

2.3. Packaging Symbols

Symbol	Symbol Note
	Fragile. Handle with care.
	This Side Up.
	Keep dry.
	Stacking layer limit, where 'n' represents the maximum permissible number of layers. (N = 6).

Chapter 3 Basic Operations

3.1. Installation



WARNING:

- The equipment should be installed by personnel designated by the manufacturer.
 - The copyright of the software of this device belongs to the manufacturer. No organization or individual can tamper with, copy or exchange any infringement by any means or form without permission.
 - Equipment connected to the analog or digital interfaces must comply with the respective IEC standards (e.g. IEC 60950 for data processing equipment and IEC 60601-1 for medical equipment). Furthermore all configurations shall comply with the current version of the standard for SYSTEMS IEC 60601-1. Everybody who connects additional equipment to the signal input part or signal output part configures a medical system, and is therefore responsible that the system complies with current version of the requirements of the system standard IEC 60601-1. If in doubt, consult the technical service department or your local representative.
 - When the equipment is connected to other electrical equipment into a combination with specific functions, if it is impossible to determine whether the combination is dangerous (for example, the electric shock hazard caused by the accumulation of leakage current), please contact the expert of the company or the hospital to ensure that the necessary safety of all equipment will not be damaged in the combination.
-

3.1.1. Unpacking and Checking

1. Unpacking

Before unpacking, examine the packing case carefully for signs of damage. If any damage is detected, contact the carrier. If the packing case is intact, open the package.

2. Remove the monitor and accessories carefully.

3. Keep all the packaging materials for future use in transportation or storage.
4. Check the monitor and accessories

Check the monitor and its accessories one by one in accordance with the packing list. Check to see if the parts have any mechanical damages. In case of problems, please contact us or our agent.



WARNING:

- **Keep the packing materials out of children's reach. Disposal of the packing materials should comply with local regulations or the hospital's waste disposal system.**
 - **The monitor might be microbial contaminated during storage and transport. Before use, please verify whether the packages, especially the package of disposable accessories are intact. In case of any damage, do not apply it to the patient.**
-

3.1.2. Environmental requirements

The operating environment of the equipment must meet the specifications in this manual.

The operating environment of the equipment should also reasonably free from the noises, vibration, dust, corrosive or flammable, explosive substances. If it is installed in the cabinet, make sure that there is enough space in front of the cabinet for operation, maintenance and repair; In order to maintain ventilation, the equipment should be at least 2 inches (5cm) away from around the cabinet.

When the equipment is transferred from one place to another, condensation may occur due to differences in temperature or humidity. At this point, you must wait for the condensation to disappear before you can use the equipment.



WARNING:

- **Please ensure the monitor is working under specified conditions; otherwise, the technical specifications mentioned in this manual will not be met, thus possibly leading to damage of equipment and other unexpected results.**
-

3.2. Getting Started

3.2.1. Connecting the Power

➤ Connecting the AC power

When the monitor need to be supplied by AC power, you can plug one end of the AC power cord into the AC power connector on the back of the monitor and the other end plug into the AC power outlet.



WARNING:

- Always use the accompanying power cord delivered with the monitor.
 - Use the battery if the integrity of the protective earth conductor or the protective earthing system in the installation is in doubt.
-

➤ Using battery

The monitor can be powered by a rechargeable lithium battery. After the battery is installed, if the external power supply is suddenly interrupted, the monitor can automatically use the lithium battery to supply the power. For the use of the battery, please refer to *Chapter 21 Battery*.

3.2.2. Starting the Monitor

After installing the monitor, you can monitor the patient.

1. Before powering on the monitor, please check whether there has mechanical damaged, external cables and accessories connect correctly.
2. Plug the power cord into an AC outlet. If using battery power, make sure there is enough power in the battery.
3. When pressing the power switch, the alarm light will display red, yellow and cyan in turn. After the alarm light is turned off, the screen will display the startup interface. After the system emits a beep, the startup screen disappears and enters the main monitoring interface.



WARNING:

- **If the monitor is damaged or does not work properly, do not use it for any monitoring procedure on a patient. And then please contact the maintenance personnel or the manufacturer immediately.**
-

3.2.3. Starting Monitoring

1. Decide what parameters should be monitored or measured.
2. Connecting required cables and sensors.
3. Check whether the connection of cables and sensors is correct.
4. Check whether all kinds of settings are correct, for example: **【Patient Type】** and **【Paced】**. For detailed information on the measurement or monitoring of each parameter, please refer to the corresponding chapters.

3.3. Shutting off the Monitor

Please follow the below steps to shut off the monitor:

1. Confirm that the patient monitoring is finished.
 2. Disconnect the cables and sensors form the monitor.
 3. Confirm that the monitoring data is stored or cleared.
 4. Press the power switch for several second, the monitor interface will pop up the shutdown dialog box, click OK to shutting off the monitor.
-



CAUTION:

- **Although not recommended, you can press and hold the power on/off switch for 5 seconds to forcibly shut down the monitor when it could not be shut down normally or under some special situations. This may cause loss of data of the monitor.**
-

**NOTE:**

- **The AC power supply of the monitor is not cuff off through the power switch. To completely disconnect the power supply, unplug the power cord.**
 - **In case of a temporary power failure, the monitor retains patient data before shutdown, including patient monitoring data and configuration data.**
-

3.4. Operation and Browse

Everything you need to operate the monitor is on its screen. Almost every element on the screen is interactive. Screen elements include parameter values, waveforms, quick keys, information area, alarms area, menus, etc. Often you can access the same element in different ways. For example, you can access a parameter setup menu by selecting corresponding parameter area or waveform area.

3.4.1. Using the Touch screen

Click on the touch screen to complete some operations quickly and easily.

In order to prevent misoperation of the touch screen, you can operate the **【Lock Screen】** quick key to temporarily lock the touch screen. After the touch screen is locked, the **【Lock Screen】** quick key become **【Unlock Screen】**, and its background color is blue, which indicating that the touch screen operation is disabled.

The lock time of the touch screen can be customized, the steps are as follows:

1. Enter the **【Other】** interface in the following ways:
 - ◆ Select **【Screen Setup】** quick key → select **【Other】** submenu;
 2. Set the **【Screen Lock Duration】**. The touch screen is unlocked under the following conditions:
 - ◆ When the set lock screen duration is reached, the touch screen is automatically unlocked.
 - ◆ Select the **【Unlock Screen】** quick key to unlock the touch screen.
-

**CAUTION:**

- **Check the touch screen whether it is damaged or breakage before use. If it is found to be damaged or broken, please stop using the monitor immediately and**

contact the service personnel.

- **If you find that the touch screen is loose, stop using the monitor immediately and contact your service personnel.**
-

3.4.2. Using the Mouse







The monitor supports the mouse with USB connector, the mouse can be plugged and unplugged. You can use the mouse to select a screen element by moving the cursor on the element and then click on it.

3.4.3. Using the Barcode scanner

The monitor supports the barcode scanner to input patient's medical record number or registration number, and connects to the monitor through USB interface

3.4.4. Using the On-Screen Keyboard

The on-screen keyboard enables you to enter information:

-  Use the key to delete the previous character.
-  Use the key to toggle between uppercase and lowercase letters.
-  Use the key to confirm what you have entered and close the onscreen keyboard.
-  Use the key to clear the entered character
-  Use the key to access the symbol keyboard.
-  Use the key to return to alphabetic keyboard.

3.5. General Settings

This chapter only introduces the general settings. For the setting of parameters and other functions, please refer to the corresponding chapter.

3.5.1. Language Settings

1. Select **【Main Menu】** →from **【System】** column to select **【Maintenance】**

→enter the maintenance password.

2. Select **【Other】** submenu.
3. Select **【Language】** and then select the desired language.
4. Restart the monitor.

3.5.2. Adjusting the Screen Brightness

The steps to set the screen brightness are as follows:

1. Set the brightness in one of the following ways:
 - ◆ Select **【Brightness】** quick key.
 - ◆ Select **【Screen Setup】** quick key→select **【Other】** submenu.
2. If the monitor operates on AC power, please set **【Brightness】**; If the monitor operates on battery power, please set **【Brightness On Battery】** .
3. When the **【Brightness】** set as **【Auto】** ,the screen will change to the brightness automatically according to the environment light intensity.



NOTE:

- When the monitor enters standby mode, the screen brightness will be automatically adjusted to the lowest.
 - When the AC power is interrupted and the battery is powered, the screen brightness is automatically set to the corresponding brightness when the battery is powered. You can still manually adjust the brightness as needed.
-

3.5.3. Setting the Date and Time

1. Select **【Main Menu】** →from **【System】** column to select **【Time】** , enter the **【System Time】** .
2. Select **【Date】** and **【Time】** to set the current date and time.
3. Select **【Date Format】** .
4. If you need to use 12 hours format, turn off **【24-Hour】** .

If the monitor is connected to the central monitoring system, the system time of the monitor will be automatically adjusted according to the time of the central monitoring system.



CAUTION:

- **When starting to use the monitor, please modify the date and time of the device according to the local time. Incorrect date and time setting may lead to misjudgment of patient trend data.**
-

3.5.4. Adjusting Volume

Select **【Sound】** quick key, Set **【Alarm Volume】** , **【High Alarm Volume】** , **【Reminder Volume】** , **【QRS Volume】** , **【Touch Tone】** and **【NIBP End Tone】** switch respectively.

3.6. Measurement Settings

3.6.1. Setting Parameters

You can manually turn the parameter switch on or off. The steps to set the parameter switch are as follows:

1. Enter **【Parameter Switch】** interface in one of the following ways:
 - ◆ Select **【Screen Setup】** quick key→select **【Param Switch】** submenu.
 - ◆ Select **【Main Menu】** quick key, from **【Parameter】** column to select **【Parameter Switch】** .
2. Turn on or off the corresponding parameters as needed

When a parameter is off, the monitor interface will not display the parameter value and waveform.

3.6.2. Setting Display Screen

You can set the parameter waveform and its order displayed in the normal interface as required. The steps are as follows:

1. Enter **【Screen Layout】** interface in one of the following ways:
 - Select **【Screen Setup】** quick key→select **【Screen Layout】** submenu.
 - Select **【Main Menu】** quick key→from **【Display】** column to select **【Screen Layout】** .
2. Select a parameter area or waveform. From the pop-up parameter list to select the elements needed to display in the area. The selected parameters and waveforms are displayed according to the set position. The parameters and waveforms that are not selected will not be displayed on the interface.



NOTE: The first line of the parameter area and the waveform area always displays the ECG parameters and the first ECG waveform.



WARNING:

- The parameters of the **【Screen Layout】** are not assigned to the display area, which will not be displayed on the monitor interface and relevant alarms for this parameter will still be provided
-

3.6.3. Setting the Parameter

Each parameter has an independent setting menu, through which alarm and parameter setting can be modified. You can enter the Parameter Setting Menu in the following ways:

- Select the parameter area or waveform area of a parameter
- Select **【Main Menu】** quick key, from **【Parameter】** column to select **【Setup】** , and then select corresponding parameter.

3.7. Operation Mode

3.7.1. Monitor Mode

Monitor mode is the most common clinical working mode used to monitor patient. When the monitor is turned on, it automatically enters the monitor mode.

3.7.2. Standby Mode

You can temporarily stop patient monitoring without switching off the monitor by entering the standby mode. You can enter the Standby Mode in the following ways:

3.7.2.1. Entering the Standby Mode

Select either way showed in the following to enter the Standby Mode:

- Press **【Standby】** quick key, or
- Select **【Main Menu】** quick key→from the **【Patient】** column to select **【Standby】** button, or
- Select **【Patient Management】** quick key→discharging patient and the enter Standby Mode.

The monitor behaves as follows after entering the standby mode:

- Stops all parameter measurements.
- Disables all the alarms and prompt messages, except for the battery low alarm.
- Turns screen brightness to the dimmest after entering the standby mode for 30 seconds.



WARNING:

- **Pay attention to the potential risk of placing the monitor to standby. In the standby mode, the monitor stops all parameters' measurements and disables all the alarm indications, except for the battery low alarm.**
-

3.7.2.2. Exit the Standby Mode

To exit the standby mode, choose any of the following ways:

- Select **【Resume Monitor】** to exit the standby mode and resume monitoring the current patient.
- Select **【Discharge Patient】** to discharge the current patient.

If the monitor automatically enters the standby mode after a patient is discharged, choose any of the following ways to exit the standby mode:

- Select **【Patient Management】** to exit the standby mode and admit a new patient.
- Select **【Monitor】** to enter the patient information for preparing to admit a new patient.

3.7.3. Demo Mode

In Demo mode, the monitor can demonstrate its major functions when patient or patient simulator is not connected. The Demo mode is password protected

Choose the following way to enter the Demo Mode:

1. Select **【Main Menu】** →from **【System】** column to select **【Demo】** .
2. Input the password→select **【OK】** .

Shut down and restart to exit the Demo Mode.



WARNING:

- **The demonstration function is mainly used to display machine performance and to train users. In the actual clinical use, it is forbidden to use the demonstration function, so as to prevent the medical staff from mistakenly thinking that the monitor displays the waveform and parameters of the monitored patient, thus affecting the patient's monitoring and delaying the diagnosis and treatment.**
-

3.7.4. Night Mode

Night mode is a special clinical monitoring mode. Under the night mode, the alarm volume, QRS volume and screen brightness turn to be lowest automatically. To avoid disturbing the patient, night mode may be used.

3.7.4.1. Entering Night Mode

The steps of entering **【Night Mode】** as following:

1. Select **【Night Mode】** quick key or select **【Main Menu】** quick key→from **【Display】** column to select **【Night Mode】** button.
2. In the pop-up menu, set the night mode.
3. Select **【Enter Night Mode】** .

The night mode settings are as follows by default:

- Brightness: 1
- Alarm Volume: 2
- QRS Volume: 1
- Touch Tone: Off
- NIBP End Tone: Off



WARNING:

- **Verify the settings of brightness, alarm volume, QRS volume and key tone before entering the night mode. Pay attention to the potential risk if the setting value is low.**
-

3.7.4.2. Exit the Night Mode

To exit the night mode, follow this step:

1. Press **【Exit Night Mode】** quick key or select **【Main Menu】** quick key→from **【Display】** column to select **【Exit Night Mode】** button.
2. In the pop-up box to select **【OK】**



NOTE: The monitor resumes the previous settings after exiting the night mode.

3.7.5. Privacy Mode

The privacy mode is a special monitoring mode. In the privacy mode, the monitor does not display patient information and monitoring data to protect patient information from non-clinicians such as visitors.

The privacy mode is only available when the patient admitted by the monitor is also monitored by the Central monitoring system. The monitor continues monitoring the patient, but patient data is only visible at the Central monitoring system.

3.7.5.1. Entering the Privacy Mode

To enter the privacy mode, choose either of the following ways:

- ◆ Select **【Main Menu】** quick key→from the **【Display】** column to select **【Privacy Mode】** button→Select **【OK】**

The monitor has the following features after entering the privacy mode:

- The screen turns blank, and prompt **【Being monitoring】** at same time.
- All parameters and waveforms display are shield.
- Except for the low battery alarm, the monitor inactivates alarm tone and alarm light of all other alarms.
- The monitor suppresses all system prompt tone, including heart beat tone, pulse tone, etc.



WARNING:

- **In Privacy mode, all audible alarms are suppressed and the alarm light is deactivated at the monitor. Alarms are presented only at the Central monitoring system. Pay attention to potential risk.**
-



CAUTION:

- **Cannot enter the privacy mode if a low battery alarm occurs.**
-

3.7.5.2. Exit the Privacy Mode

The monitor automatically exits the privacy mode in any of the following situations:

- ◆ The monitor disconnects from the Central Monitoring System.
- ◆ The low battery alarm occurs.

You can also press **【Exit Privacy Mode】** on the screen to manually exit the privacy mode.

3.8. Using the Timer

The monitor provides timer function, which can display up to four timers at the same time. You can set each timer separately, which prompts when the set time arrives.

3.8.1. Displaying Timer

To display a timer, follow this procedure:

1. Access **【Screen Layout】** in either of the following ways:
 - ◆ Select **【Screen Setup】** quick key→Select **【Screen Layout】** submenu.
 - ◆ Select **【Main Menu】** quick key→from the **【Display】** column to select **【Screen Layout】** .
2. Click the parameter area where you want to display the timer, select **【Timer】** → select **【Timer1】** , **【Timer2】** , **【Timer3】** , **【Timer4】** .

3.8.2. Controlling the Timer

The timer provides the following controls:

【Start】: Start the timer.

【Pause】: Pause the timer.

【Resume】: Resume the timer.

【Reset】: Clear the current timing results and reset the timer.



WARNING:

- **Do not use the timers to schedule critical patient-related tasks.**
-

3.8.3. Setting the Timer

You can set each timer independently. To set the timer, follow this procedure:

1. Select the timer area to enter the **【Timer】** menu.
 2. Set **【Timer Type】** :
 - ◆ **【Normal】**: The timer is timed according to the present **【Run Time】**. Stop timing when running time is reached.
 - ◆ **【Cycled】**: The timer cycles, that is, the timer counts according to the preset **【Run Time】**, and starts timing again after reaching the run time. The timer area displays the number of timer cycles.
 - ◆ **【Unlimited】**: The timer displays the time elapsed since the timer was started.
 3. Set **【Direction】**
 4. Set **【Run Time】**
 5. Set **【Reminder Volume】** When the remaining time is 10 seconds, the monitor issues a reminder tone and the timer flashes in red, prompting you that the run time is to expire.
-



CAUTION:



- Cannot change timer settings when a timer is running.
 - Set **【Direction】**, **【Run Time】** and **【Reminder Volume】** only for **【Normal】** or **【Cycled】**.
-

3.9. Voice Assistant

The voice assistant can be used as an auxiliary input interface. You can issue specific control commands to the monitor via voice. After the monitor recognizes the command, it performs the corresponding operation function.



The method of operating the voice assistant as following:

1. Select **【Voice Assistant】** quick key, open the voice assistant function, the icon " " will display on the top of status bar.

2. Say the wake-up words. At this time, the top status bar will display the " " icon, indicating that the monitor is in the state of voice recognition control command.
 3. When the control command is spoken, the monitor will recognize the command and perform the corresponding operation, at this time, " " icon disappears and the " " icon is displayed.
-



CAUTION:

- **Every time before you say a control command, you must say the wake-up word to wake up the voice assistant at first. After waking up (the top status bar displays the " " icon) , if the control command is not spoken within 7 seconds, the voice assistant will enter the sleep state again (top The status bar displays the " " icon) , you need to re-execute the “Wake-up” → “Control Command” voice operation.**
 - **When using the voice assistant, try to be as close as possible to the monitor.**
 - **Please avoid using the voice assistant in noisy environments.**
-



NOTE:

- **The specific wake-up words and supported voice commands will show in the voice assistant screen.**
-

Chapter 4 Patient Management

4.1. Discharging a Patient

Before monitoring a new patient, discharge the previous patient. After the patient is discharged, all patient data, including patient information, trend data, and physiological alarm information is deleted from the monitor, the technical alarms are reset, and monitor settings returns to their defaults (current configuration or user-specified configuration). For more information, see *5.2 Setting Default Configuration*.

After discharging a patient, the monitor automatically admit a new patient.



WARNING:

- Always discharge the previous patient before starting monitoring a new patient. Failure to do so can lead to data being attributed to the wrong patient.
-



NOTE:

- Discharging a patient deletes all history data of current patient in the monitor.
-

Discharge a patient manually using either of the following methods:

- ◆ Select **【Discharge Patient】** quick key.
- ◆ Select the patient information area at the top left of the screen→Select **【Discharge Patient】**
- ◆ Select **【Patient Management】** quick key→Select **【Discharge Patient】**
- ◆ Select **【Main Menu】** from **【Patient】** column to select **【Discharge Patient】**

In the pop-up dialog box to select:

- **【OK】** : All patient data, including patient information, trend data, and physiological alarm information, are cleared. The technical alarm status is reset and the system reverts to its default configuration and enters into the standby screen.

- **【Cancel】** : Exit the operation of discharging patient data and return to the main interface.

4.2. Admitting a Patient

The monitor admits a new patient in the following situations:

- After discharging a patient, the monitor automatically admit a new patient.
- From the standby screen, select **【Discharge Patient】** to admit a new patient.

Always inputs patient information as soon as the patient is admitted. For more information please refer to *4.3.2 Editing Patient Information* for details.



WARNING:

- **【Patient Type】** and **【Paced】** will always contain a value, regardless of whether the patient is fully admitted or not. If you do not specify settings for these fields, the monitor uses the default settings from the current configuration, which might not be correct for your patient.
 - For paced patients, you must set **【Paced】** to **【Yes】**. If it is incorrectly set to **【No】**, the monitor could mistake a pace pulse for a QRS and fail to alarm when the ECG signal is too weak.
 - For non-paced patients, you must set **【Paced】** to **【No】**.
-

4.3. Managing Patient Information

4.3.1. Patient Management menu

Use any of the following methods to enter the **【Patient Management】** menu:

- Select patient information area at the top left corner of the screen.
- Select **【Patient Management】** quick key.
- Select **【Main Menu】** →from **【Patient】** column to select **【Patient Management】**.

4.3.2. Editing Patient Information

Edit patient information after a patient has been admitted, or when patient information is incomplete, or when you want to change patient information.

To edit patient information, follow this procedure:

1. Enter the **【Patient Management】** menu. For more information, please refer to *4.3.1 Patient Management menu*.
2. Select patient type according to the actual situation: **【Big Animal】**, **【Small Animal】**.
3. Edit patient information as required.

If your monitor is connected with the barcode scanner, you can enter the medical record number by scanning the barcode.



NOTE:

- The setting of patient type determines the algorithm used by the monitor to process and calculate certain measurements, as well as the safety limit and alarm limit range applicable to certain measurements.
 - The monitor reloads the configuration when the patient type is changed.
-

4.3.3. Setting the Display Item

You can set whether to display and edit patient room number, name, age, and so on in the **【Patient Management】** menu by following these steps:

1. Select **【Main Menu】** quick key→from **【System】** column to select **【Maintenance】** →input password→Enter.
2. Select **【Patient Management】** submenu→ **【Field】** submenu.
3. Select which the patient information needs to be displayed and edited in the **【Patient Management】** menu.
4. Select customizes the patient information section, if necessary, and enters the name of the section.

4.4. Connecting to a Central Monitoring System

If your monitor is connected to a central monitoring system (CMS) manufactured by Biolight:

- The monitor sends patient information, real-time monitoring or measurement data, alarm limits, alarm levels, alarm messages, prompts, and various settings to the central monitoring system.
- The central monitoring system and the monitor display synchronously, and some functions can be controlled bidirectionally. For example, change patient information, receive patient data, cancel patient data, etc.
- Alarm delay to the central monitoring system: the alarm delay time from this equipment to the central monitoring system is $\leq 2s$.

For details, refer to the CMS's instructions for use.

Chapter 5 Managing Configurations

5.1. Introduction

When performing continuous monitoring on a patient, the clinical professional often needs to adjust the monitor's settings according to the patient's condition. The collection of all these settings is called a configuration. The configuration of the monitor includes: parameter configuration, alarm configuration and monitor configuration. You can change some settings from a certain set of configuration and then save the changed configuration as a user configuration.



WARNING:

- **The configuration management function is password protected. The configuration management tasks must be performed by clinical professionals.**
-

5.2. Selecting default configuration

The default configuration can be the factory default configuration or a user configuration that has been stored.

You can use the following steps to select the default configuration:

1. Select **【Main Menu】** quick key→from **【Configuration】** column to select **【Set Default Config】** →input maintenance password→Enter.
2. Select **【Factory Default】** or **User-defined configuration**.

When selecting user-defined configuration, only one user configuration that has been stored under the current patient type can be selected.

5.3. Saving current settings

Current settings can be saved as user configuration. Up to 10 user configurations can be saved. The steps to protect the current settings are as follows:

1. Select **【Main Menu】** quick key→from **【Configuration】** column to select **【Save User Config】** →enter maintenance password→Enter.
2. In the popup dialog box of **【Save User Config】** , input the configuration name.

3. Select **【OK】**

5.4. Deleting a configuration

You can delete the saved user configurations by following these steps:

1. Select **【Main Menu】** quick key→from **【Configuration】** column to select **【Delete User Config】** →input maintenance password→Enter.
2. Select the configuration you want to remove:
In the**【Delete User Config】**menu, the currently existing user configuration on the monitor is displayed.
3. Select **【Delete】** button.
4. In the popup dialog box to select **【OK】**



CAUTION:

- The current configuration in use cannot be deleted.
-

5.5. Transferring a configuration

The monitor provides configuration transfer function. You can use a USB drive to transfer the configuration from one monitor to another monitor that needs the same settings without having to reset them item by item. The monitor supports transferring the monitor configuration with USB disk.

5.5.1. Exporting a configuration

You can export the monitor's current user configuration to a USB drive by following these steps:

1. Connect the USB drive to the monitor's USB port.
2. Select **【Main Menu】** quick key→from **【Configuration】** column to select **【Export User Config】** →input maintenance password→Enter.
3. Select configuration that needs to be exported.
4. Select **【OK】** .

5.5.2. Importing a configuration

You can import the user configuration to the monitor through a USB drive by following these steps

1. Connect the USB drive to the monitor's USB port.
2. Select **【Main Menu】** quick key→from **【Configuration】** column to select **【Import User Config】** →input maintenance password→Enter.
3. Select configuration that needs to be imported.
4. Select **【OK】** .

5.6. Loading current configuration

You may make changes to some settings during operation. However, these changes or the pre-selected configuration may not be appropriate for the newly admitted patient. Therefore, the monitor allows you to load a desired configuration so as to ensure that all the settings are appropriate for your patient.

To load a configuration by following these steps:

1. Select **【Main Menu】** quick key→from **【Configuration】** column to select **【Load Current Config】** .
2. Select configuration that needs to be loaded.
3. Select **【OK】** .

5.7. New Patient Usage Configuration

When receiving patients, you can select loading the nearest configuration or the specified configuration. You can set the default configuration by following these steps:

1. Select **【Main Menu】** quick key→from **【Configuration】** column to select **【New Patient Config】** →input maintenance password→Enter.
2. Select **【Default】** or **【Current】**
 - **【Default】** : The monitor loads the default configuration specified by the user when it receives the patient, please refer to *5.2 Selecting Default Configuration.*
 - **【Current】** : The monitor loads the nearest configuration when it receives the patient.

5.8. Monitor Boot Usage Configuration

When the monitor starts, you can select whether the monitor loads the nearest configuration or the specified configuration. You can set the default configuration by following these steps:

1. Select **【Main Menu】** quick key→from **【Configuration】** column to select **【Boot Config】** →input maintenance password→Enter.
2. Select **【Default】** or **【Current】** .
 - **【Default】** : The monitor loads the default configuration specified by the user the user when it starts. Please refer to *5.2 Selecting Default Configuration*.
 - **【Current】**: The monitor loads the nearest configuration when it starts.

5.9. Setting password valid time

If you access the configuration management menu and use the password to access alarm-related settings, you can set a valid time for the password, beyond which you will need to re-enter the password.

Please follow the steps below:

1. Select **【Main Menu】** quick key→from **【System】** column to select **【Maintenance】** →input maintenance password→Enter.
2. Select **【Authorization】** submenu.
3. Set **【Retention Time】** .

Chapter 6 User Interface

6.1. Interface Style

You can set the style of the interface as needed.

6.1.1. Changing the Screen Layout

You can select the parameters and waveforms you want to view in the **【Screen Layout】** window. For details, please refer to **3.6.2 Setting Display Screen.**

6.1.2. Selecting Screen

The conventional screen is the most commonly used clinical monitoring screen for the monitor, and the monitor enters the normal screen after being turned on. You can also select the screen type as needed, the steps are as follows:

1. Enter **【Select Screen】** interface in one of the following ways:
 - Select **【Screen Setup】** quick key→Select **【Screen Select】** submenu.
 - Select **【Main Menu】** quick key→from **【Display】** column to select **【Screen Select】**
2. Select screen types as needed.

6.1.3. Setting Big Font Screen

1. Enter **【Screen Layout】** interface in one of the following ways:
 - Select **【Screen Setup】** quick key→Select **【Screen Layout】** submenu.
 - Select **【Main Menu】** quick key→from **【Display】** column to select **【Screen Layout】**.
2. Select **【Big Font】** submenu.
3. Click on each locale to display the parameters you want to display.

6.1.4. Changing Parameter Color

The steps for setting colors of parameter values and waveforms are as follows:

1. Select **【Main Menu】** quick key→from **【Parameter】** column to select **【Param Color】** .
2. Select **【Current Select】** submenu to set the colors of parameter values and waveforms.
3. Select **【All】** submenu to set the colors of all parameter values and waveforms.

6.2. Dynamic Trend Screen

6.2.1. Entering Dynamic Trend Screen

The Dynamic Trend window is located to the left of the waveform area, showing the trend of a series of parameters in a recent period of time. You can enter the Dynamic Trend screen in any of the following ways:

- Select **【Screen Setup】** quick key→Select **【Screen Select】** submenu→Select **【Dynamic Trend】** .
- Select **【Main Menu】** quick key→from **【Display】** column to select **【Screen Select】** →Select **【Dynamic Trend】** .

In the Dynamic Trend window, the parameter label name of the trend is displayed above each trend curve, and the trend scale is displayed on the left. Trend times are displayed at the bottom of the window.

6.2.2. Setting the Trend Time

Follow these steps to set the trend time:

1. Enter the Dynamic Trend window.
2. Select the Dynamic Trend area, open **【Dynamic Trend】** menu.
3. Select **【Trend Length】**

6.2.3. Exiting Dynamic Trend Screen

You can exit the Dynamic Trend screen by any of the following methods:

- Select **【Screen Setup】** quick key→Select **【Screen Select】** submenu→Select the screen you need to enter.
- Select **【Main Menu】** quick key→from **【Display】** column to select **【Screen Select】** →Select the screen you need to enter.

6.3. OxyCRG screen

The OxyCRG screen graphically displays high-resolution trend curves and compressed waveforms of HR, SpO₂, and RR.

6.3.1. Entering OxyCRG screen

You can enter the OxyCRG screen by any of the following methods:

- Select **【Screen Setup】** quick key→Select **【Screen Select】** submenu→Select **【OxyCRG View】** .
- Select **【Main Menu】** quick key→from **【Display】** column to select **【Screen Select】** →Select **【OxyCRG View】** .

The OxyCRG screen shows two trend curves and a compression waveform.

6.3.2. Select Display Parameters and Scales

Follow the steps below to set the parameters of the OxyCRG screen:

1. Enter OxyCRG screen.
2. Select **【Setup】** .
3. Set **【Trend 1】** , **【Trend 2】** , **【Compressed Wave】** separately.
4. Select **【Scale】** submenu, set the scales of each parameter. If you want to use the default scaleplate of the system, select the **【Default Scale】** on the OxyCRG screen.

6.3.3. Setting the Trend Time

Follow the steps below to set the Trend Time:

1. Enter OxyCRG screen.
2. Select **【Zoom】**.

6.3.4. Entering OxyCRG Review Screen

You can review the 48-hour trend curve and compression waveform on the OxyCRG Review Screen. Follow these steps to go to the OxyCRG Review Screen:

1. Enter OxyCRG screen.

2. Select **【Review】** .

6.4. Other Bed Observation

You can check the alarm status and real-time physiological data of patients on other remote monitors in the LAN on the monitor. A remote monitor (such as a bedside monitor) is also called other bed monitor. You can monitor the alarms of up to 16 other beds at the same time, and you can also view the waveform of 1 other bed from the current monitor.

You can monitor the alarm of other bed through the alarm monitoring area of **【Other Bed View】** interface.



CAUTION:

- **Can view the monitor through the remote monitor. You can check the alarm and waveform of this monitor from 5 remote monitors at the same time.**
-

6.4.1. Other Bed Screen

Through the **【Other Bed View】** screen, you can check the real-time parameters and waveforms of a remote monitor and monitor the alarm of other monitors.

6.4.1.1. Entering Other Bed Screen

Entering other bed screen by any of the following methods:

- ◆ Select **【Remote View】** quick key.
- ◆ Select **【Screen Setup】** quick key → Select **【Screen Select】** submenu → Select **【Other Bed View】** .

6.4.1.2. Other Bed Interface

Below is other bed observation interface:



1. Other bed observation area: Display the patient information, alarm status, information, waveform and parameters of the selected bed. You can move the interface down to browse the contents of the interface.
2. Other bed monitoring area
 - Displays all remote monitors being monitored.
 - Display the equipment number of other bed monitor, and indicate other bed monitor's alarm status with different background colors:
 - Red: Indicates that other bed monitor is giving high priority physiological or technical alarm, and the high priority alarm is the highest level alarm in the current alarm of the bed.
 - Yellow: Indicates that other bed monitor is giving medium priority physiological or technical alarm. The medium priority alarm is the highest level alarm in the current alarm of the bed.
 - Cyan: Indicates that the monitor is giving low priority physiological or technical alarm, and the low priority alarm is the highest level alarm in the current alarm of the bed.
 - Green: Indicates that the monitor is connected successfully and no alarms have occurred.
 - Gray: Indicates that the monitor is not connected successfully.
 - Gray with : Indicates that the monitor is disconnected during the connection process.

6.4.1.3. Adding Other Bed

Only add other bed monitor, the device can monitor alarm of other bed. If you have added other bed monitor, you can up to a choice of 16 beds. Add other bed as follows:

1. Select other bed observation interface area, in the pop-up window **【Bed View Settings (Bed number)】** to select **【Bed】** submenu.
2. Select the device number of the monitor to be observed in the list.
 - The setup interface mainly displays the device number, IP, and patient information of the networked monitor.
 - Select **【Show Offline Bed】** to display the device numbers of all monitors.

6.4.1.4. Delete Bed

If you no longer need to monitor the remote monitor, you can remove it as follows:

1. Select other bed observation interface area, in the pop-up window **【Bed View Settings (Bed number)】** to select **【Bed】** submenu.
2. Cancel the device number of the monitor in the list. If you want to delete all beds, you can select **【Delete All】** .

6.4.1.5. Display Main Bed

In the other bed monitoring area of its bed observation window, select a bed and then other bed observation window will display the real-time monitoring interface of the monitor. This selected bed is called the main bed.

6.4.1.6. Alarm information Display

You can follow these steps to view the current real-time alarm information of the main bed:

1. Enter **【Alarm】** interface by one of the following methods:
 - Click on the alarm information display area of the bed observation area, and the alarm interface will pop up.
 - Select other bed observation interface area, in the pop-up window **【Bed View**

Settings (Bed number) to select **Alarm** submenu.

2. In **Alarm** submenu to check the current physiological and technical alarm information of the main bed.

6.4.1.7. Reset Other Bed Alarm

In the **Bed View Settings (Bed number)** window→select **Reset Remote Alarm** which in the **Alarm** submenu, the alarm of the corresponding remote monitor (main bed) is reset. Only when this function is turned on can you reset other bed alarm. For detailed, please refer to *7.12.1 Other Bed Alarm Reset*.

6.4.1.8. Selecting Waveform

Other bed observation area can display up to 4 waveforms. Following these steps to select the label name of the waveform you want to observe:

1. Select other bed observation interface area, in the pop-up window **Bed View Settings (Bed number)** to select **Wave** submenu.
2. In proper order to select **First Wave**, **Second Wave**, **Third Wave** and **Fourth Wave**, then select the label name of the waveform in the pop-up list. If you select is **Close**, then the display of one waveform will be turned off.

6.4.1.9. Selecting Parameters

Other bed observation can display all the online parameters. Select the parameter label names you want to observe as follows:

1. Select other bed observation interface area, in the pop-up window **Bed View Settings (Bed number)** to select **Param** submenu.
2. Open the parameter labels you want to observe in the displayed list of online parameters.



WARNING:

- **The data displayed will delay in other bed observation window. Don't rely on other bed observation window for real-time data.**

6.5. Big Font Screen

You can enter big numerics screen in either of the following ways:

- Select **【Screen Setup】** quick key→Select **【Screen Select】** submenu→Select **【Big Font Screen】** .
- Select **【Main Menu】** quick key→from **【Display】** column to select **【Screen Select】** →Select **【Big Font Screen】** .

In the setting window of **【Big Font Screen】**, you can select 6 parameters to observe according to your needs. For parameters with waveform, one waveform is displayed at the same time.

6.6. Freezing Waveforms

During monitoring the patient, you can freeze the waveform on the screen and then review it to carefully observe the patient during this time. You can also export the frozen waveform through the recorder.

6.6.1. Entering Freezing Status

1. Under the non-freezing condition, select **【Freeze】** quick key, and then pop-up **【Freeze】** menu.



2. All waveforms are frozen, that is, the waveforms are not refreshed. The data in the parameter area is refreshed normally.

6.6.2. Waveform Review

On the freezing waveforms screen you can operate the following:

- In the frozen status, you can select the control icon to browse the frozen waveforms: the frozen waveform will move to the left or right correspondingly. At the same time, each waveform is marked with a time scale, and the freezing time is recorded as **【0s】**. As the waveform moves to the right, the time scale will be gradually changed to

【-1s】 , 【-2s】 , 【-3s】

Icon	Function
<<	Up to the first page
<<	Up to the previous page
<	Up to the previous second
>	Down to the next second
>>	Down to the next page
>>	Down to the last page

- You can set the speed of the frozen waveform as needed.

6.6.3. Releasing Freezing

Under freezing condition, you can select button  in the upper right corner of the freezing menu to release the freezing condition.

6.6.4. Recording Freezing Waveforms

Select the **【Record】** button in **【Freeze】** , the recorder will output the waveform selected and the parameter value at the Freezing time. The recorder can output up to 3 waveforms at one time. For the setting of frozen waveforms, please refer t to **19.6.1** *Selecting the record waveforms.*

Chapter 7 Alarm

7.1. Introduction

This chapter introduces the alarm function and the settings of the monitor.

7.2. Safety Information



WARNING:

- A potential hazard can exist if different alarm presets are used for the same or similar equipment in any single area, e.g. an intensive care unit or cardiac operating room.
- Alarm Settings for different monitors in the same area may vary to suit the condition of the patient being monitored. Before starting the patient monitoring, check whether the alarm setting is suitable for the patient, and always open certain necessary alarm limits, and ensure that the alarm limit setting is suitable for the patient.
- If your monitor is connected to the central monitoring system (CMS) or other monitors, alarms can be displayed and controlled remotely. Remote suspension, inhibition, or silence of monitor alarms via the CMS or other monitors may cause a potential hazard. For details, refer to the operator's manual of the CMS and the other monitors.
- Setting the alarm limit to the highest may invalidate the alarm system.
- When the alarm sound is turned off, even if a new alarm is triggered, the monitor will not emit an alarm sound. Therefore, the user must carefully select whether to turn off the alarm sound. Check patient status frequently after turning off alarm or alarm sound.
- For patients who cannot be continuously treated by medical staff, the alarm settings must be made according to the patient's condition.
- Do not rely solely on an audible alarm system to monitor a patient. There may be risks in adjusting the alarm sound to a lower volume, which may impede operator recognition of alarm. The alarm volume should be large enough in the

current monitoring environment and the actual clinical condition of the patient should be paid close attention.



NOTE:

- **When the alarm system is powered off, the monitor will save the alarm information before power interruption, and the stored alarm information will not change.**
-

7.3. About the alarm

7.3.1. Alarm Categories

The monitor has two different types of alarms: physiological alarms and technical alarm.

- **Physiological alarms:** Physiological alarms are triggered by a monitored parameter value that violates set alarm limits or an abnormal patient condition.
- **Technical alarms:** Technical alarms are triggered by a device malfunction due to improper operation or system problems. The problems may result in system abnormal operation or irresponsible monitoring parameters.

Apart from the physiological and technical alarm messages, the monitor will also display some information related to system status or patient status.

7.3.2. Alarm Priority

By severity, the monitor's alarms can be classified into three categories:

- **High priority:** Indicate that the patient is in a life threatening situation or a severe device malfunction, and an emergency treatment is necessary.
- **Medium priority:** Indicate that your patient's vital signs appear abnormal, a severe device malfunction or an improper operation, and an immediate treatment is required.
- **Low priority:** Indicate that the patient's vital signs appear abnormal, a severe device malfunction or an improper operation, the user needs to know the

current situation.

- Prompt: Prompt patient and system status information.

7.3.3. Alarm Indicators

When an alarm occurs, the monitor will indicate it to the user through visual or audible alarm indications:

Alarm signal		High priority alarm	Medium priority alarm	Low priority alarm	Prompt	Note
Alarm Lamp		The lamp quickly flashes red with 1.4Hz~2.8Hz, Duty cycle 20%-60%.	The lamp slowly flashes yellow with 0.4Hz~0.8Hz, Duty cycle 20-60%.	The lamp turns cyan without flashing, Duty cycle 100%.	/	/
Alarm Tone Mode	ISO	DO-DO-DO--D O-DO ----- DO-DO-DO-- DO-DO -----	DO-DO-DO -	DO-	/	/
Alarm Information		White words, Red background	Black words, Yellow background	Black words, Cyan background	White words	Displayed in the top information area, click on the alarm information to view the alarm information list.
Alarm level symbol		***	**	*	/	Displayed in front of alarm information.
Parameter alarm		Red background, flashes	Yellow background, flashes	Cyan background, flashes	/	/



WARNING:

- When multiple alarms of different priorities occur simultaneously, the alarm lamp and alarm tone are prompted according to the highest level of all current

alarms.

- **When there are multiple alarms in the same area at the same time, the alarm messages are displayed circularly on the screen.**
-

7.3.4. Alarm Status Symbols

In addition to the alarm methods described in section *Alarm Indicators*, the following alarm icons will appear on the screen to indicate different alarm states:



Indicates an alarm for a parameter is off or the alarm system is off.



Indicates all the alarms are paused.



Indicates the alarm sound is off.



Indicates alarms are reset.

7.4. Viewing physiological alarms list

The steps of viewing physiological alarms are as follows:

1. Select physiological alarms area to enter **【Alarm Informations】** window.
2. Select **【Phy. Alarm】** submenu.

7.5. Viewing technical alarms list

The steps of viewing technical alarms list are as follows:

1. Select technical alarms area to enter **【Alarm Informations】** window.
2. Select **【Tec. Alarm】** submenu.

7.6. Setting Alarm

You can set the alarm properties centrally. Select **【Alarm Setup】** quick key or select the corresponding button from the **【Alarm】** column, in the main menu to set alarm.

7.6.1. Setting Parameter Alarm

The steps to centrally set the properties of the parameter alarm are as follows:

1. Enter **【Limit】** interface in any of the following ways:
 - Select **【Alarm Setup】** quick key.

- Select **【Main Menu】** quick key→from**【Alarm】**column to select**【Limit】**.
2. Select parameter submenu to set the alarm according to the required. You can also set the alarm for individual parameters from the parameters menu.

7.6.2. Changing Alarm Setup Protection Mode

You can change the password protection mode of the alarm settings and arrhythmia settings as follows:

1. Select **【Main Menu】** quick key→from **【System】** column to select **【Maintenance】** →input maintenance password→Enter.
2. Select **【Authorization】** submenu.
3. Change the password protection mode of the alarm settings.
 - **【No Password】** : Change alarm setups to not be password protected.
 - **【Password】** : Change alarm switch, alarm limit and alarm level to be protected by password.

If you use password to access alarm and arrhythmia alarm related settings, you can set the valid time of the password, beyond which you need to re-enter the password. For details, please refer to *5.9 Setting Password Valid Time*.

7.6.3. Setting Alarm Sound Properties

7.6.3.1. Setting Alarm Volume

1. Enter **【Setup】** interface in either of the following ways:
 - Select **【Alarm Setup】** quick key→Select **【Setup】** submenu.
 - Select **【Main Menu】** quick key→from **【Alarm】** column to select **【Setup】** .
2. Set **【Alarm Volume】** . The alarm volume range is X-10, in which X is the minimum volume, depending on the set minimum alarm volume, and 10 is the maximum volume.
3. Set **【High Alarm Volume】** .
4. Set **【Reminder Volume】** .



NOTE:

- When the alarm volume is set to 0, the alarm tone will be turned off, and an alarm audio off icon will appear on the screen.
 - When the alarm volume is set to 0, the setting of high level alarm volume is invalid.
-

7.6.3.2. Setting the minimum alarm volume

The minimum alarm volume determines the minimum alarm volume setting. The steps are as follows:

1. Select **【Main Menu】** quick key→from **【System】** column to select **【Maintenance】** →input maintenance password→Enter.
 2. Select **【Alarm】** submenu→ **【Sound】** submenu.
 3. Select **【Minimum Alarm Volume】** .
-



NOTE:

- You can set the minimum alarm volume to 0 only when you are connected to the CMS. If the monitor is not connected to the CMS, the minimum alarm volume can only be set to 1.
 - When the CMS is connected, if the minimum alarm volume is set to 0, the minimum alarm volume will be automatically changed to 2 when the CMS is disconnected.
-

7.6.3.3. Setting Alarm Tone Mode

The setting steps are as follows:

1. Select **【Main Menu】** quick key→from **【System】** column to select **【Maintenance】** →input maintenance password→Enter.
2. Select **【Alarm】** submenu→ **【Sound】** submenu→ **【Alarm Sound】** , you can select **【ISO】** .

7.6.3.4. Setting Alarm Tone Interval

You can set the alarm tone interval. The steps are as follows:

1. Select **【Main Menu】** quick key→from **【System】** column to select

- 【Maintenance】** →input maintenance password→Enter.
2. Select **【Alarm】** submenu→ **【Sound】** submenu.
 3. Set **【High Alarm Interval】**, **【Med Alarm Interval】** and **【Low Alarm Interval】**
 - **【High Alarm Interval】** : 3~15s, and the default value is 10s.
 - **【Medium Alarm Interval】** : 3~30s, and the default value is 20s.
 - **【Low Alarm Interval】** : 16~30s, and the default value is 20s.

7.6.3.5. Setting Reminder Volume

When the alarm volume is 0, alarm reset or the alarm is off, the monitor can provide periodic alarm prompt tone to remind you that there is still an activated alarm in the current system. This function is turned on by default.

You can set the alarm tone as follows:

1. Select **【Main Menu】** quick key→from **【System】** column to select **【Maintenance】** →input maintenance password→Enter.
2. Select **【Alarm】** button→ **【Pause /Reset】** submenu.
3. Set **【Alarm Pause duration】**. You can set **【Alarm Pause duration】** to **【1min】**, **【2min】**, **【3min】** or **【Permanent】**, the default is **【2min】**.
4. Set **【Alarm Off Reminder】** switch.
 - **【On】** : The monitor provides an alarm tone according to the set interval.
 - **【Off】** : The monitor does not provide an alarm tone.
5. Set **【Reminder Interval】**. You can set **【Reminder Interval】** to **【1min】**, **【2min】**, **【3min】**, **【5min】** or **【10min】**, the default is **【5min】**.

7.6.3.6. Setting Alarm Tone Enhancement

The monitor provides an alarm tone enhancement function. If the alarm exceeds the set time and is not confirmed, the alarm volume can be automatically enhanced.

The steps to set the alarm tone enhancement are as follows

1. Select **【Main Menu】** quick key→from **【System】** column to select **【Maintenance】** →input maintenance password→Enter.

2. Select **【Alarm】** → **【Sound】**
3. Set **【Auto Increase Volume】** to **【3 Steps】** , **【2 Steps】** , **【1 Steps】** or **【Off】**
 - **【3 Steps】** : After the alarm occurs, the alarm volume will be automatically increased to level 3, if the set time is not confirmed.
 - **【2 Steps】**: After the alarm occurs, the alarm volume will be automatically increased to level 2, if the set time is not confirmed.
 - **【1 Steps】**: After the alarm occurs, the alarm volume will be automatically increased to level 1, if the set time is not confirmed.
 - **【Off】**: After the alarm occurs, the set time is not confirmed, and the alarm volume remains unchanged.
4. Set **【Increase Volume Delay】**, select sound enhanced delay time.

7.6.4. Setting Alarm Delay Time

For the over-limit alarm of continuous measurement parameters, the alarm delay time can be set. If the condition of triggering alarm disappears within the delay time, the monitor will not alarm.

Set the delay time for the alarm by following these steps:

1. Select **【Main Menu】** quick key→from **【System】** column to select **【Maintenance】** →input maintenance password→Enter.
2. Select **【Alarm】** submenu→ **【Other】** submenu.
3. Set **【Alarm Delay】**

The delay time of the apnea alarm is not affected by the alarm delay time setting. You can set the delay time of the apnea alarm separately.

7.6.4.1. Setting Apnea Alarm Delay Time

Steps to set apnea alarm delay time are as follows:

1. Enter **【Setup】** interface in either of the following ways:
 - Select **【Alarm Setup】** quick key→Select **【Setup】** submenu.
 - Select **【Main Menu】** quick key→from **【Alarm】** column to select

【Setup】

2. Select **【Apnea Delay】** to set apnea alarm delay time.

7.6.5. Setting Alarm Waveform Length

You can set the length of the waveform needs to be output when an alarm occurs, the setting steps are as follows:

1. Enter **【Setup】** interface in either of the following ways:
 - Select **【Alarm Setup】** quick key→Select **【Setup】** submenu.
 - Select **【Main Menu】** quick key→from **【Alarm】** column to select **【Setup】** .
 - Select **【Main Menu】** quick key→from **【Report】** column to select **【Record Setup】** .
2. Set **【Alarm Record Duration】** .

7.6.6. Setting CMS Disconnect Alarm Switch

You can set whether to alarm when the monitor and the CMS are disconnected. This function is enabled by default. The setting method is as follows:

1. Select **【Main Menu】** quick key→from **【System】** column to select **【Maintenance】** →input maintenance password→Enter.
2. Select **【Alarm】** submenu→ **【Other】** submenu.
3. Open or Close **【CMS Disconnected】** .

When the **【CMS Disconnected】** switch is turned on, the technical alarm will be generated when the monitor and the CMS are disconnected after successful connection.

7.7. Alarm Pause

When the alarm is paused, it has the following characteristics:

- Shield all physiological alarms within the set time.
- The technical alarm sound is paused, but the alarm light and alarm information are still displayed.

- Display the remaining time of alarm paused in the physiological alarm information area.
- Display the alarm paused icon in the information area.

After reaching the alarm pause time, the monitor will automatically exit the alarm pause state. You can also click **【Alarm Pause】** quick key to manually cancel the alarm pause.

7.7.1. Setting Alarm Pause Time

Alarm pause time can set to : **【2min】**、**【5min】**、**【30min】** and **【Permanent】** , the default is permanent. The steps to set the alarm pause time are as follows:

1. Select **【Main Menu】** quick key→from **【System】** column to select **【Maintenance】** →input maintenance password→Enter.
2. Select **【Alarm】** submenu→ **【Pause /Reset】** submenu.
3. Set **【Alarm Pause Duration】** .

7.7.2. Turn off all the Alarm

If **【Alarm Pause Duration】** is set to **【Permanent】** (Refer to section 7.7.1 *Setting Alarm Pause Time*), you can press **【Alarm Pause】** quick key to turn off all alarms. When the alarm is turned off, it has the following characteristics:

- No physiological alarm lamps flash and no physiological alarms are sounded.
- The technical alarm sound is turned off, but the alarm light and alarm information are still displayed
- Display "**Alarm Off**" in the physiological alarm information area and the background color is red.
- Display alarm off icon in status area.

To exit the alarm off state, click **【Alarm Pause】** quick key again.



WARNING:

- **Pausing or turning off the alarm may cause the patient to be in danger, please handle it carefully.**

7.8. Alarm Reset

Click on **Alarm Reset** quick key to reset the alarm system, and the alarm reset icon will appear in the system status information area.



NOTE:

- **In the alarm reset state, if a new alarm is generated, the alarm reset icon disappears and the alarm system is reactivated.**

7.8.1. Physiological Alarm Reset

After the physiological alarm is reset, the sound of the currently existing physiological alarm is shielded, and the other alarm states remain unchanged.

7.8.2. Technical Alarm Reset

When the technical alarm is reset, it has the following characteristics:

- The technical alarm that can be completely cleared is cleared. The monitor will not have any alarm indication for the cleared technical alarm.
- Technical alarm that can clear sound and light is displayed as prompt message.
- The sound of the technical alarm that cannot be cleared is shielded. For the indication of the technical alarm after the alarm is reset, please refer to ***D.2 Technical Alarm.***

7.9. Latching Alarms

The physiological alarms are classified into “Latching” and “Non-latching”.

- Non-latching alarms: After the condition that triggered the alarm of a parameter disappears, the system will not make any prompt for this alarm of this parameter.
- Latching alarms: Even if the condition that caused the physiological alarm disappears, the alarm signal will still be “Latched”, and the time of the last triggering of the alarm will be displayed behind the alarm information in the

information area.

- You can choose to individually lock the visual signal or simultaneously lock the visual and audible signals.
- For visual latching, after the alarm condition disappears, the visual signal of the alarm, including the alarm light, the alarm information and the background color remain unchanged, and the alarm information text is followed by the time of last triggering the alarm.
- For audible latching, the system still emits an alarm tone after the alarm condition disappears.

The steps to latch the physiological alarm are as follows:

1. Select **【 Main Menu 】** quick key→from **【 System 】** column to select **【 Maintenance 】** →input maintenance password→Enter.
2. Select **【 Alarm 】** submenu→ **【 Latching 】** submenu.
3. Select how you want to latch the alarms. Alarm latching rules are as follows:
 - You can separately select visual latching.
 - Latching audible alarm signal simultaneously latches visual signal corresponding to the alarm level.
 - When a low priority alarm is latched, the high priority alarm is also automatically locked. For example, if you select the low priority alarm, the medium priority alarm and the high priority alarm will also be latched simultaneously.



CAUTION:

- **Changing of alarm priority may affect the latching status of corresponding alarm. Please determine if you need to reset the latching status for the specific alarm when you have changed its alarm priority.**
- **When the alarm system is reset, the latched physiological alarms are cleared.**
- **Do not set all alarm status to latching alarm signals when used in the intensive care unit.**

7.10. Nurse Call

The nurse call function means that when the alarm set by the user occurs, the monitor

can output a signal to the nurse call system, call the nurse. The monitor provides a nurse call connector, and the monitor is connected to the nurse call system of the hospital through the randomly provided nurse call cable. After the system is connected, the connector can implement the nurse call function.

The nurse call function must be valid only if the following conditions are met:

- ◆ The nurse call function is turned on.
- ◆ A user-defined alarm occurs.
- ◆ The monitor is not alarm paused or off.

7.10.1. Changing Nurse Call Settings

To set the type and priority of alarms that are sent to the nurse call system, follow this procedure:

1. Select **【Main Menu】** quick key→from **【System】** column to select **【Maintenance】** →input maintenance password→Enter.
2. Select **【Alarm】** submenu→ **【Nurse Call】** submenu.
3. Select **【Signal Type】** to set the type of nurse call signal.
 - ◆ **【Pulse】**: The nurse call signal is a pulse signal and each pulse lasts one second. When multiple alarms simultaneously occur, only one pulse signal is outputted. If an alarm occurs but the previous one is not cleared, a new pulse signal will also be outputted.
 - ◆ **【Continuous】** : The nurse call signal lasts until the alarm ends. That is to say the duration of a nurse call signal is equal to that of the alarm condition.
4. Select **【Trigger Type】** to set the work mode of the nurse call relay.
5. Select **【Alarm Priority】** to set the priority of alarms sent to the nurse call system.
6. Select **【Alarm Type】** to set the type of alarms sent to the nurse call system.



WARNING:

- **Do not rely exclusively on the nurse call system for alarm notification.**

Remember that the most reliable alarm notification combines audible and visual alarm indications with the patient's clinical condition.

7.11. Intubation Status

The monitor provides the intubation status function during RESP and CO2 monitoring. In this state, the physiological alarms related to RESP and CO2 are shielded, and the alarm off icon is displayed in the parameter area. During the intubation process of general anesthesia surgery, the intubation status can be selected to shield unnecessary alarms.

7.11.1. Entering Intubation Status

To enter the intubation status, choose either of the following ways:

- ◆ Select **【Intubation Status】** quick key.
- ◆ From the bottom of the **【RESP】** or **【CO2】** menu to select **【Intubation Status】** button.
- ◆ Select **【Main Menu】** quick key→from **【Alarm】** column to select **【Intubation Status】** .

7.11.2. Setting Intubation Status Time

The default intubation time is 2 minutes. To change the time, following this procedure:

1. Select **【Main Menu】** quick key→from **【System】** column to select **【Maintenance】** →input maintenance password→Enter.
2. Select **【Alarm】** submenu→**【Other】** submenu.
3. Set **【Intubation Duration】** .

7.11.3. Exiting the Intubation Status

To exit the intubation status, choose either of the following ways:

- Select **【Intubation Status】** quick key.
- From the bottom of the **【RESP】** or **【CO2】** menu to select **【Exit】**

Intubation Status button.

- Select **【Main Menu】** quick key→from **【Alarm】** column to select **【Exit Intubation Status】** .

7.12. Other Bed Alarm

Enter other bed observation interface, and when the monitored bed monitor has an alarm triggered, the alarm light and alarm sound are prompted according to the highest level of all alarms of the current monitor and other bed monitor. You can view and manage other bed alarm.

The alarm delay time from the device to other bed is $\leq 2s$.

7.12.1. Other Bed Alarm Reset

You can reset other bed alarm on the monitor. The steps to enable it to reset the bed alarm are as follows:

1. Select **【Main Menu】** quick key→from **【System】** column to select **【Maintenance】** →input maintenance password→Enter.
2. Select **【Alarm】** submenu→ **【Remote View】** submenu.
3. Open **【Reset Remote Bed's Alarms】** .

And then **【Bed View Settings (bed number)】** window→ **【Reset Remote Alarm】** button in the **【Alarm】** submenu will be activated. Click on **【Reset Remote Alarm】** button, other bed alarm will be reset.



CAUTION:

- Only when the “Alarm Reset By Other Bed” function of the remote monitor is enabled, can you reset other bed alarm on this monitor
-

7.12.2. Authorizing the Alarm Reset to Other Devices

Alarms on your monitor can be reset by remote devices if you enable this function. To do so, follow this procedure:

1. Select **【Main Menu】** quick key→from **【System】** column to select

1. **【Maintenance】** →input maintenance password→Enter.
2. Select **【Alarm】** submenu→ **【Remote View】** submenu.
3. Open **【Alarm Reset by Other Bed】** switch.

7.12.3. Switching Off the Remote Device Disconnection Alarm

The monitor can provide an alarm if remote devices are disconnected. By default, the function is enabled. To disable the alarm, follow this procedure:

1. Select **【Main Menu】** quick key→from **【System】** column to select **【Maintenance】** →input maintenance password→Enter.
2. Select **【Alarm】** submenu→ **【Remote View】** submenu.
3. Switch off **【Remote Disconnected Alarm】** .

7.13. Detecting Alarm

The monitor automatically performs a self-test at startup. Check that the alarm lamp illuminates, one after the other, in red, yellow, and cyan, and that an alarm tone is heard. This indicates that the visible and audible alarm indicators functions correctly.

To further test individual measurement alarms, perform measurements on yourself or using a simulator. Adjust alarm limits and check that appropriate alarm behavior is observed

7.14. Actions When an Alarm Occurs

When an alarm occurs, please refer to the following steps to take proper actions:

1. Check the patient's condition.
2. Confirm the alarming parameter or alarm category.
3. Identify the source of the alarm.
4. Take proper action to eliminate the alarm condition.
5. Check if the alarm is eliminated.

For more information, please refer to *D Alarm Information*.

Chapter 8 ECG

8.1. Introduction

The electrocardiogram (ECG) measures the electrical activity of the heart and displays it on the monitor as waveforms and parameters. The monitor provides 3-lead, 5-lead, 6-lead, and 12-lead ECG monitoring, arrhythmia analysis, ST segment analysis and QT/QTc measurements.

8.2. Safety Information



WARNING:

- **This equipment is not intended for direct cardiac application.**
 - **Make sure the conductive parts of electrodes and associated connectors for applied parts, including the neutral electrode, should not contact any other conductive parts including earth.**
 - **Use defibrillation-proof ECG cables during defibrillation.**
 - **Do not touch the patient or metal devices connected to the patient during defibrillation.**
 - **To reduce the hazard of burns during high-frequency surgical procedure, ensure that the monitor's cables and transducers never come into contact with the electrosurgery unit (ESU).**
 - **To reduce the hazard of burns during use of high-frequency surgical unit (ESU), the ECG electrodes should not be located between the surgical site and the ESU return electrode.**
-



CAUTION:

- **Only use parts and accessories specified in this manual. Follow the instructions for use and adhere to all warnings and cautions.**
- **Regularly inspect the electrode application site to ensure skin quality. If there are signals of allergies, replace the electrodes or change the application site.**



- **Interference from a non-grounded instrument near the patient and electrosurgery interference can cause problems with the waveform.**

8.3. ECG Display

The following figures show the ECG waveform and parameter areas. Your display may be configured to look slightly different.

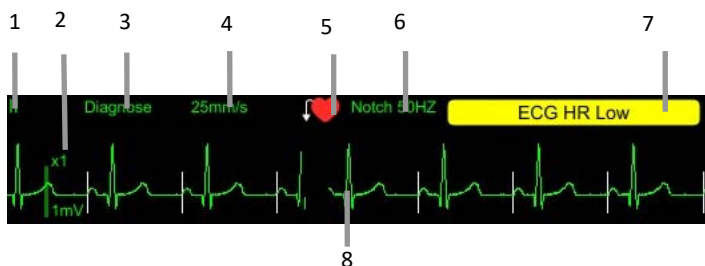
◆ **Waveform Display**



- (1). ECG lead label
- (2). ECG waveform gain
- (3). ECG filter mode
- (4). ECG waveform speed
- (5). Paced status: If **【Paced】** is set to **【Yes】**,  is displayed; If **【Paced】** is set to **【No】**,  is displayed.
- (6). Notch frequency
- (7). Alarm message: Display only the highest level of alarm information.
- (8). Pace pulse mark: If **【Paced】** is set to **【Yes】**, the pace pulse markers are shown on each ECG waveform when the patient has a paced signal.

◆ Parameter Display

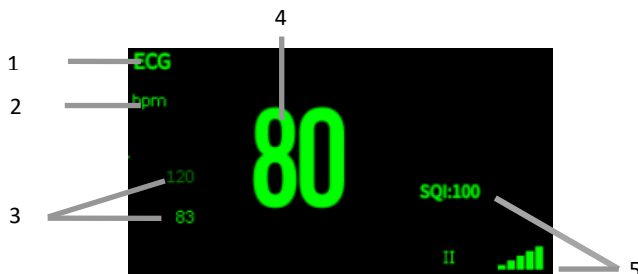

- (1) Parameter label
- (2) HR unit
- (3) HR alarm limit: If the HR alarm is turned off, the alarm close icon is displayed here.
- (4) HR value
- (5) ECG signal quality index: Indicates the signal quality of the primary calculation lead.



NOTE:

- The ECG parameter area and waveform area are configured to be different for different lead type and ECG settings.

8.4. Preparing for ECG Monitoring

8.4.1. Preparing the Patient Skin

Proper skin preparation is necessary for good signal quality at the electrode sites, as the skin is a poor conductor of electricity. Sites where leads are attached to the body must be properly prepared to optimize contact.

Dogs and cats have enough electrolyte material on their skin and hair so that merely moistening lead sites with 70% isopropyl alcohol is appropriate. This will usually be sufficient for ECG monitoring for a short time, 30 to 60 minutes, depending upon the relative humidity.

For monitoring during longer periods, an electrode paste should be used. It is best to first wet the hair at the lead attachment site with alcohol; then place paste on the moistened

hair and skin. It is important that the paste be in direct contact with skin. For animals with dense undercoat, rub paste with fingers to assure that it has made contact with skin.

8.4.2. Applying Electrodes

To connect ECG cables, follow this procedure:

1. Attach the ECG leadwires to the clips prior to placement.
2. The clips are supplied with this monitor and they must open wide enough to firmly but gently grasp the skin.
3. Connect the ECG leadwires to the patient cable.
4. Plug the patient cable into the ECG connector.

8.4.3. Lead Wire Color Code

The following table lists the 5-lead labels and colors for AHA and IEC standards:

Lead	IEC		AHA	
	Label	Color	Label	Color
Right arm	R	Red	RA	White
Left arm	L	Yellow	LA	Black
Right leg (neutral)	N/RF	Black	RL	Green
Left leg	F	Green	LL	Red
Chest	C	White	V	Brown

The following table lists the 6-lead labels and colors for AHA and IEC standards:

Lead	IEC		AHA	
	Label	Color	Label	Color
Right arm	R	Red	RA	White
Left arm	L	Yellow	LA	Black
Right leg (neutral)	N/RF	Black	RL	Green
Left leg	F	Green	LL	Red
Chest 1	Ca	White	Va	Brown
Chest 2	Cb	White	Vb	Brown

The following table lists the 12-lead labels and colors for AHA and IEC standards:

Lead	IEC		AHA	
	Label	Color	Label	Color
Right arm	R	Red	RA	White
Left arm	L	Yellow	LA	Black
Right leg (neutral)	N/RF	Black	RL	Green
Left leg	F	Green	LL	Red
Chest1	C1	White/ Red	V1	Brown/ Red
Chest 2	C2	White/Yellow	V2	Brown/Yellow
Chest 3	C3	White/Green	V3	Brown/Green
Chest 4	C4	White/Brown	V4	Brown/ Blue
Chest 5	C5	White/Black	V5	Brown/ Orange
Chest 6	C6	White/ Purple	V6	Brown/ Purple

8.4.4. ECG Electrode Placements

In this section, we adopt the AHA standard to illustrate electrode placement.

8.4.4.1. 3-lead Electrode Placement

Taking the AHA standard as an example, the 3-lead electrode placement position is as shown:

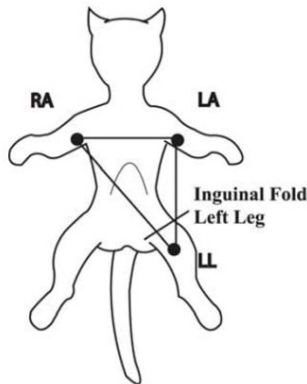

- ◆ RA(right arm) lead: on the right foreleg.

- ◆ LA(left arm) lead: on the left foreleg.
- ◆ LL(left leg) lead: on the left hindleg.

8.4.4.2. 5-lead and 6-lead Electrode Placement

Taking the AHA standard as an example, the 5-lead electrode placement position is as shown:

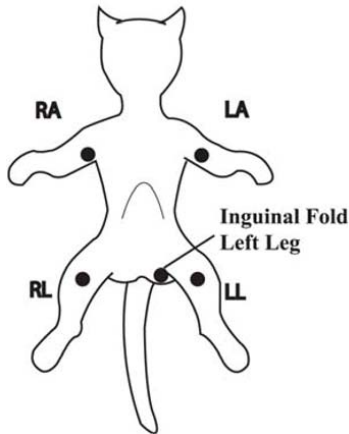

- ◆ RA (right arm) lead: on the right foreleg.
- ◆ LA (left arm) lead: on the left foreleg.
- ◆ RL (right leg) lead: on the right hindleg.
- ◆ LL (left leg) lead: on the left hindleg.
- ◆ V (precordial) lead: exploring lead.



NOTE:

- **The exploring lead is used for diagnostic purposes as needed. Otherwise, it may be left unplugged.**

For 6-lead placement, you can use the position for the 5-lead placement, but with two chest leads. The two chest leads (Va and Vb) can be placed according to the physician's preference.

8.4.4.3. 12-lead Electrode Placement

12-lead ECG uses 10 electrodes, which are placed on the patient's four limbs and chest. The limb electrodes should be placed on the soft skin and the chest electrodes placed according to the physician's preference.

8.4.4.4. Electrode Placement for Surgical Patients

While placing electrodes for a surgical patient, the type of surgery should be considered, for instance, as to a chest surgery, the chest lead electrodes can be placed at sides or backside of chest. Moreover, while using a surgical electrotome, in order to reduce the influence of artifacts to ECG waveform, the electrodes can be placed at left and right shoulders, close to left and right sides of abdomen; the chest lead electrodes can be placed at left side of chest midst. Do not place the electrodes on the upper arm. Otherwise, the ECG waveform will be very small.



WARNING:



- **To reduce the hazard of burns during use of electrosurgical units (ESU), the ECG electrodes should not be located between the surgical site and the ESU negative electrode plate.**
 - **Never entangle the ESU cable and the ECG cable together.**
 - **When using ESU, never place ECG electrodes near to the negative electrode plate of the ESU, as this can cause a lot of interference on the ECG signal.**
-

8.4.5. Selecting ECG Lead Type

To select ECG lead type, follow this procedure:

1. Select ECG parameter area or waveform area to enter the **【ECG】** menu.
2. Select **【Setup】** submenu.
3. Set **【Lead Type】** according to the lead type you are going to use.
 - **【Lead Type】** is set as **【Auto】**, the monitor automatically detects the lead type.

8.4.6. Checking Paced Status

It is important to correctly set the paced status before you start monitoring ECG. The paced symbol  is displayed when **【Paced】** is set to **【Yes】**. The pace pulse markers " | " are shown on each ECG waveform when the patient has a paced signal. If **【Paced】** is set to **【No】** or the patient's paced status is not selected, the symbol  will be shown in the ECG waveform area.

To change the paced status, follow this procedure:

1. Select ECG parameter area or waveform area to enter the **【ECG】** menu.
 2. Select **【Paced】** submenu.
 3. Set **【Paced】** to be **【Yes】** or **【No】**. If you did not set the paced status, the monitor issues a prompt tone when pace pulse is detected. At the same time, the paced symbol  flashes and the message prompt "Suspected Pacing Signal". Check and set the patient's paced status.
-



WARNING:

- For paced patients, you must set **【Paced】** to **【Yes】**. If it is incorrectly set to **【No】**, the monitor could mistake a pace pulse for a QRS complex and fail to alarm when the ECG signal is too weak.
 - False low heart rate or false asystole alarms may result with certain pacemakers because of pacemaker artifacts, such as electrical overshoot of the pacemaker overlapping the true QRS complexes.
 - Do not rely entirely on rate meter alarms when monitoring patients with pacemakers. Always keep these patients under close surveillance.
 - For non-paced patients, you must set **【Paced】** to **【No】**.
-

8.4.7. Enabling Pacer Rejection

The pace pulse rejection function is disabled by default. To enable this function, follow this procedure:

1. Select ECG parameter area or waveform area to enter the **【ECG】** menu.

2. Select **【Paced】** submenu.
 3. Switch on **【Pacer Reject】** .
-

**NOTE:**

- When pace pulses are detected, the pace pulse marks “|” are shown on the ECG waveforms. **【Pacer Reject】** setting has no impact on the display of pace pulse marks “|”.
 - You can switch on **【Pacer Reject】** only when **【Paced】** is set to **【Yes】** .
-

8.5. ECG Settings

8.5.1. Selecting ECG Screen

When monitoring ECG, you can choose the screen as desired.

- ◆ For 3-lead ECG monitoring, only normal screen is available.
- ◆ For 5-lead ECG monitoring, besides the normal screen, it can be selected to display 7 waveforms.
- ◆ For 6-lead ECG monitoring, besides the normal screen, it can be selected to display 8 waveforms.
- ◆ For 12-lead ECG monitoring, besides the normal screen, it can be selected to display 12 waveforms.

To choose the screen type, follow this procedure:

1. **【Screen Select】** interface in one of the following ways:
 - Select **【Screen Setup】** quick key→Select **【Screen Select】** submenu.
 - Select **【Main Menu】** quick key→from **【Display】** column to select **【Screen Select】** .
2. Select **【ECG Screen】** .

8.5.2. Setting ECG Alarm

To set ECG alarm properties, follow this procedure:

1. Select the ECG parameter area or waveform area to enter the **【ECG】** menu.
2. Select **【Alarm】** submenu.
3. If the alarm settings are password protected, enter the password. For details, please refer to *7.6.2 Changing Alarm Setup Protection Mode*.
4. Set alarms as needed.

8.5.3. Setting ECG calculating Lead

You can set the label name of the ECG calculation lead as follows:

1. Select ECG parameter area or waveform area to enter the **【ECG】** menu.
2. Select **【Setup】** submenu.
3. Select **【ECG 1】** or **【ECG 2】** to set label name of ECG calculating Lead.



WARNING:

- Only when you switch on **【MultiLead Ana】** can you set **【ECG 2】** .
-

8.5.4. Setting Multi-lead Analysis

When multi-lead analysis function is switched on, the **【ECG 2】** participate in the calculation of HR, the steps to set up the multi-lead analysis switch are as follows:

1. Select ECG parameter area or waveform area to enter the **【ECG】** menu.
2. Select **【Setup】** submenu.
3. Switch on or off **【MultiLead Ana】** .



CAUTION:

- **【ECG 1】**is the key calculation lead; **【ECG 2】**is the auxiliary calculation lead.
Only when the ECG **【Lead Type】** is 5/6/12 lead can you set**【MultiLead Ana】**.
-

8.5.5. Setting ECG Waveform

8.5.5.1. Setting ECG Waveform Gain

If the ECG waveform is too small or clipped, you can change its amplitude by selecting an appropriate gain setting. To do so, follow this procedure:

1. Select ECG parameter area or waveform area to enter the **【ECG】** menu.
2. Select **【Gain】** submenu.
3. Set the size of each ECG waveform. If you select **【Auto】**, the monitor automatically adjusts the gain of the ECG waveforms.

8.5.5.2. Setting ECG Waveform Speed

To change ECG waveform speed, follow this procedure:

1. Select ECG parameter area or waveform area to enter the **【ECG】** menu.
2. Select **【Setup】** submenu.
3. Set **【Wave Speed】**.

8.5.5.3. Setting ECG Filter Mode

To set the ECG waveform filtering mode, follow this procedure:

1. Select ECG parameter area or waveform area to enter the **【ECG】** menu.
2. Select **【Setup】** submenu.
3. Set **【Filter Mode】**.
 - ◆ **【Diagnose】**: Use when diagnostic quality is required. The unfiltered ECG waveform is displayed so that changes such as notch on R-wave, ST elevation or depression, etc.
 - ◆ **【Monitor】**: Use under normal measurement conditions.
 - ◆ **【Operation】**: Use when the signal is distorted by high frequency or low frequency interference. High frequency interference usually results in large amplitude spikes making the ECG signal look irregular. Low frequency interference usually leads to wandering or rough baseline. The surgery filter reduces artifacts and interference from electrosurgical

units. Under normal measurement conditions, selecting **【Operation】** may suppress the QRS complexes.

- ◆ **【ST】** : It is recommended to use in ST segment analysis.

Filter status in various ECG modes:

ECG mode \ Filter	Drift filter	EMG filter	Notch Filter
Diagnose	Weak	Weak	Optional
Monitor	Moderate	Moderate	On
Operation	Intense	Intense	On
ST	Weak	Moderate	Optional



NOTE:

- Under the mode of **【Operation】** and **【Monitor】**, the state of the filter cannot be regulated. Only under the state **【Diagnose】** and **【ST】** can adjust the notch filter status. Please select **【Monitor】** during monitoring a patient, select **【Operation】** under the state of great interference.
- The diagnose mode has passed the distortion test.

8.5.5.4. Setting Notch Filter

The notch filter can eliminate power frequency interference. Follow the steps below to turn the notch switch on or off:

1. Select ECG parameter area or waveform area to enter the **【ECG】** menu.
2. Select **【Setup】** submenu.
3. Switch on or off **【Notch Filter】** .



NOTE:

- Only the **【Filter Mode】** is set to **【Diagnose Mode】** or **【ST】** can you switch

on or off **【Notch Filter】** , other mode is enabled by default.

8.5.5.5. Setting Notch Filter Frequency

According to the mains frequency of your country, you can set the frequency of the notch to **【50Hz】** or **【60Hz】** . If you need to change the **【Notch Frequency】** , please contact the manufacturer maintenance personnel.

8.5.6. Setting Smart Lead Switch

This monitor provides the function of switching main lead automatically. When switch on **【Smart Lead】** (**Smart lead auto switchover**), the current smart leads are automatically identified by the algorithm, and the host automatically switches the smart leads according to the identification of the algorithm.

Steps of switching off smart lead function are as follows:

1. Select ECG parameter area or waveform area to enter the **【ECG】** menu.
2. Select **【Setup】** submenu.
3. Switch off **【Smart Lead】** .

8.5.7. Setting the Priority of the ECG Lead Off Alarm

The steps to set the alarm level for ECG lead off alarms are as follows:

1. Select **【Main Menu】** quick key→from **【System】** column to select **【Maintenance】** →input maintenance password→Enter.
2. Select **【Alarm】** submenu→ **【Other】** submenu.
3. Set **【ECG Lead Off Alarm Level】** .

8.5.8. Adjusting the QRS Volume

The QRS volume is determined by **【Alarm Source】** in the ECG or PR alarm setting menu. Which parameter (HR or PR) is set to **【Alarm Source】** and the QRS volume is sounded according to which parameter's rhythm.

The volume of QRS sound can be set, the steps are as follows:

1. Select ECG parameter area or waveform area to enter the **【ECG】** menu.

2. Select **【Setup】** submenu.
3. Set **【QRS Volume】**

When valid SpO2 measurements are available, the monitor adjusts the pitch tone of QRS volume based on the SpO2 value. For detail, please refer to *10.5.5 Setting Pitch Tone*.

8.5.9. Setting Multi-lead Signal Quality

The signal quality of the ECG waveform provides two display modes. The monitor displays the signal quality of the main calculated lead waveform by default. You can set the signal quality of the multi-lead waveform as required. The setting steps are as follows:

1. Select ECG parameter area or waveform area to enter the **【ECG】** menu.
2. Select **【Setup】** submenu.
3. Switch on **【MultiLead Signal】** .

Multi-lead Signal Quality: The color of the ECG signal of all leads is indicated by the waveform color respectively. The five colors of white, red, orange, yellow and green respectively correspond to the five signal quality levels of extreme bad, bad, general, good and excellent.

When switch off **【MultiLead Signal】** ,

Main-lead Signal Quality: The signal quality of the main calculation lead is indicated by a triangular diagram of 5 grids, and 1 to 5 grids respectively correspond to five signal quality levels of extreme bad, bad, general, good and excellent. The signal quality is displayed above the icon (SQI) value, which unit is "%".

8.5.10. Setting ECG Standard

Select the ECG standard according to the leads you are using. To select the ECG standard, follow this procedure:

1. Select **【Main Menu】** quick key→from **【System】** column to select **【Maintenance】** →input maintenance password→Enter.
2. Select **【Module】** submenu→ **【ECG】** submenu.
3. Set **【ECG Standard】** to **【AHA】** or **【IEC】** .

8.6. Arrhythmia Monitoring

Arrhythmia analysis provides information about your patient's condition, including heart rate, PVC rate, rhythm and ectopics.

8.6.1. Safety Information



WARNING:

- Arrhythmia may affect heart rate. When monitoring arrhythmia patients, do not rely entirely on the alarm information calculated by heart rate, but always place the patients under close surveillance.
 - Arrhythmia function is applicable for detecting certain ventricular and atrial arrhythmias, not all atrial or supraventricular arrhythmias. Sometimes, it may detect wrong arrhythmia. Therefore, doctors must combine more clinical manifestations to analyze arrhythmia information.
-



CAUTION:

- Since the arrhythmia detection algorithm sensitivity and specificity is less than 100%, sometimes there may be some false arrhythmias detected and also some true arrhythmia events may not be detected. This is especially true when the signal is noisy.
 - The amplitude of ECG waveform will affect the arrhythmia detection and heart rate calculation sensitivity.
 - If the QRS amplitude is too low, the monitor may not be able to calculate the heart rate and false asystole may occur.
 - Arrhythmia detection may not be available during ECG relearning. Therefore, the patient's state should be closely observed during ECG relearning and within a few minutes after completion.
-

8.6.2. Arrhythmia Events

This section lists all arrhythmia events and their criteria.

S12 Vet Monitor User's Manual

Arrhythmia Events	Description
Asystole	There is no fluctuation or very small and slow waveform for 6 seconds.
Vent Fib/Tach	Ventricular fibrillation waveform for 4 seconds.
V-Tach	More than 5 (including 5) ventricular waveforms were detected continuously, and the heart rate was greater than the ventricular tachycardia heart rate limit.
Vent Brady	More than 3 (including 3) ventricular waveforms were detected continuously, and the heart rate was less than the ventricular bradycardia limit.
Extreme Tachy	Non-ventricular rhythm and the heart rate are greater than the extreme tachycardia limit.
Extreme Brady	Non-ventricular rhythm and the heart rate are less than the extreme bradycardia limit.
R on T	Ventricular premature beats appear on the T wave of the previous cardiac cycle.
Tachy	Non-ventricular rhythm and the heart rate are greater than the tachycardia limit.
Brady	Non-ventricular rhythm and heart rate less than bradycardia limit.
Nonsustained V-Tach	Three or four consecutive ventricular waveforms and the heart rate are greater than the ventricular tachycardia heart rate limit.
Vent Rhythm	More than 5 (including 5) ventricular waveforms were detected continuously, and the heart rate was less than the ventricular tachycardia heart rate limit and greater than the ventricular bradycardia heart rate limit.
PNC	One cardiac leak and one pacing pulse were detected.
PNP	One cardiac leak was detected, but no pacing pulse was detected.
Pause	No heartbeat is detected within $1.75 \times$ of the average R-R interval (when the heart rate is less than 100), or no heartbeat is detected within 1 second (when the heart rate is more than 100) and the current RR interval is greater than 4 seconds and less than 6 seconds.
Pauses/min High	The number of Pause per minute is greater than the decision limit.
Run PVCs	For 3 or 4 consecutive ventricular waveforms, the heart rate is less than the ventricular tachycardia heart rate limit and greater than the ventricular bradycardia heart rate limit.
Couplet	Two consecutive ventricular waveforms.

Arrhythmia Events	Description
Bigeminy	Dominant rhythm of N, V, N, V.
Trigeminy	Dominant rhythm of N, N, V, N, N, V.
Frequent PVCs	The number of PVC per minute is greater than the decision limit.
PVC	Occasional ventricular premature beat.
Missed Beat	No heartbeat is detected within $1.75 \times$ of the average R-R interval (when the heart rate is less than 100bpm), or no heartbeat is detected within 1 second (when the heart rate is more than 100bpm) and the current RR interval is less than 4 seconds.
A-Fib	RR interval of normal cardiac beats is irregular and there is no P wave.
A-Fib End	No atrial fibrillation was detected within the delay time after the end of atrial fibrillation.
ECG Noise	There is too much noise to analyze the waveform.
Irregular Rhythm	Always an irregular rhythm.
Irregular Rhythm End	No irregular rhythm was detected within the delay time after the end of the irregular rhythm.

8.6.3. Arrhythmia alarm settings

Use the following steps to set arrhythmia related alarms:

1. Select ECG parameter area or waveform area to enter **【ECG】** menu.
2. Select **【ARR】** submenu→ **【Alarm】** submenu.
3. If the arrhythmia setting is protected by a password, enter the password. For details, please refer to **7.6.2 Changing Alarm Setup Protection Mode**.
4. Set each arrhythmia alarm as required.



NOTE: The alarm level for lethal arrhythmia is always high and cannot be changed by the user.

8.7. ST Monitoring

ST segment of ECG waveform refers to the phase from the end of ventricular depolarization to the beginning of ventricular repolarization, or from the end of QRS complex (point J) to the beginning of T wave. ST segment analysis is mostly used to

monitor the oxygen supply and myocardial viability of patients.

8.7.1. Safety Information



WARNING:

- **Factors such drugs, metabolism or conduction disorders may affect ST values.**
 - **Since ST is calculated by a fixed delay after point J, it may be affected by changes in heart rate.**
 - **The data accuracy of ST algorithm has been tested, and its clinical significance should be decided by doctors.**
 - **The monitor provides ST segment change information, and the clinical opinion of this information should be decided by the doctor.**
-

8.7.2. Enabling ST Monitoring

The ST segment analysis function is disabled by default. Please enable ST segment analysis according to the following steps:

1. Select ECG parameter area or waveform area to enter **【ECG】** menu.
2. Select **【ST】** submenu→**【Setting】** submenu.
3. Switch on the **【ST Analysis】**. The following clinical situations may make it difficult to obtain reliable ST monitoring:
 - ◆ Lead with low noise cannot be obtained.
 - ◆ Arrhythmia leading to irregular baseline exists, such as atrial fibrillation/atrial flutter.
 - ◆ The patient is continuously performing ventricular pacing.
 - ◆ The patient has left bundle branch block.

When these situations exist, you should consider turning off the ST segment analysis function.

8.7.3. Displaying ST parameter

The method of displaying ST parameters and waveforms is as follows:

1. Enter the **【Screen Layout】** page in one of the following ways:

- ◆ Select **【Screen Setup】** quick key→select **【Screen Layout】** submenu.
 - ◆ Select **【Main Menu】** quick key→from **【Display】** column to select **【Screen Layout】** .
2. Click on the location in the parameter area where ST parameters need to be displayed, and select **【ECG】** → **【ST】** . Depending on the type of lead you are using, the ECG parameter area displays different ST parameters:
- ◆ When using 3-lead monitoring, an ST parameter value is displayed in the ECG parameter area but not in the ST parameter area.
 - ◆ When using 5-lead monitoring, the ST parameter area displays 7 ST parameter values, namely ST-I, ST-II, ST-III, ST-aVR, ST-aVL, ST-aVF and ST-V respectively.
 - ◆ When 6-lead monitoring is used, the ST parameter area shows the same values of 8 ST parameters, namely ST-I, ST-II, ST-III, ST-aVR, ST-aVL, ST-aVF, ST-Va and ST-Vb.
 - ◆ When 12-lead monitoring is used, the ST parameter area displays 12 ST parameter values, namely ST-I, ST-II, ST-III, ST-aVR, ST-aVL, ST-aVF, ST-V1, ST-V2, ST-V3, ST-V4, ST-V5, and ST-V6.

Take 5-lead as an example, the ST parameter area is shown as follows:



- (1) Parameter label
- (3) ST alarm off symbol
- (2) ST unit
- (4) Lead label
- (5) ST numerics: a positive value indicates ST segment elevation, and a negative value indicates ST segment depression.

8.7.4. Displaying ST Segment in Waveform Area

The steps for displaying ST segment in waveform area are as follows:

1. Enter the **【Screen Layout】** page in one of the following ways:
 - ◆ Select **【Screen Setup】** quick key→select **【Screen Layout】** submenu.
 - ◆ Select **【Main Menu】** quick key→from **【Display】** column to select **【Screen Layout】** .
2. Click on the waveform area where you need to display ST segment, and select **【ECG】** → **【ST segment】** from the list.

The ST waveform area displays the current ST segment waveform and baseline waveform, the current ST value and baseline value. Generally, the current ST segment and parameter values are displayed in green, while the baseline segment and parameter values are displayed in white.

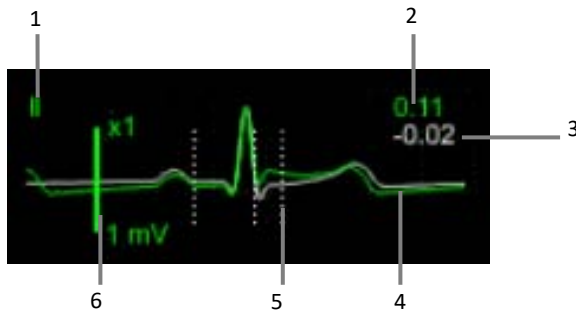

- (1) ST lead
- (2) The current ST value
- (3) ST baseline value
- (4) The current ST segment (green) and baseline ST segment (white)
- (5) ST segment measurement position line
- (6) Scale

8.7.5. Entering ST View

ST View displays a complete QRS segment of each ST lead. You can enter **【ST View】** to view these ST segments. The color of the current ST segment and ST value is

the same as that of ECG waveform, usually green. ST baseline segment and baseline value are white.

You can select the ST waveform area to enter the **【ST View】** page or enter the **【ST View】** page through the following steps:

1. Select ECG parameter area, waveform area or ST parameter area to enter **【ECG】** menu.
2. Select **【ST】** submenu.
3. Select **【ST View】** from the bottom of the menu.

8.7.6. Saving the ST Baseline

ST analysis requires valid samples. Set an ST baseline when ST values become stable. If you do not set a baseline, the monitor will automatically save a set of baselines about 5 minutes after a valid ST measurement appears. You can also manually update the baseline by selecting **【Set Baseline】** in the lower left corner of the **【ST View】** interface.

You can also make the following settings under the ST interface:

- Select **【Show Baseline】** or **【Hide Baseline】** to show or hide ST baseline segments and parameter values.
- Select **【Show Mark】** or **【Hide Mark】** to show or hide ST reference point, J point and ST point positions.



CAUTION:

- **Changing the ST baseline will affect the ST alarm.**
-

8.7.7. Entering ST Graphic Window

The steps to enter the ST Graphic window are as follows:

1. Select ECG parameter area, waveform area, ST parameter area or ST waveform area to enter **【ECG】** menu.
2. Select **【ST】** submenu.
3. Select **【ST Graphic】** from the bottom of the menu.

The following figure shows ST Graphic. The height of the bar represents the ST value of the corresponding ST lead. The color of the bar indicates the ST alarm status: green indicates that the ST value is within the normal range; Cyan, yellow and red indicate that the ST value exceeds the alarm limit. The alarm color corresponds to the level of ST alarm.

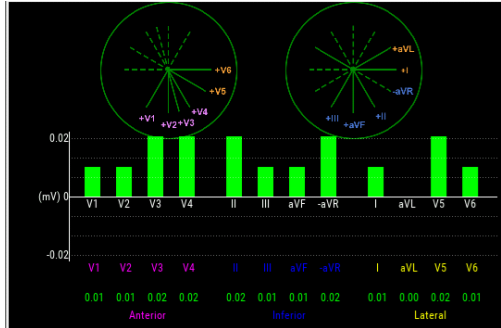

8.7.8. ST Setup

8.7.8.1. Setting ST Alarm

ST alarm is set as follows:

1. Select ECG parameter area, waveform area or ST parameter area to enter **【ECG】** menu.
2. Select **【ST】** submenu→ **【Alarm】** submenu.
3. Set the properties of ST alarm as required.

8.7.8.2. Showing ISO Point, J Point and ST Point Marks

The ISO point, J point and ST point position marks are not displayed by default on the ST segment in the waveform area. To display these marks, the steps are as follows:

1. Select ECG parameter area, waveform area, ST parameter area or ST waveform area to enter **【ECG】** menu.
2. Select **【ST】** submenu→ **【Setting】** submenu.
3. Switch on **【ST Mark】**.

8.7.9. Adjusting ST Measurement Point

8.7.9.1. ST Point, ISO Point and J Point

The ST value for each beat complex is the vertical difference between the isoelectric (ISO) point and the ST point. The ISO point provides the baseline. The ST point is at the midpoint of the ST segment. The J point is where the QRS complex changes its slope. As the J point is a fixed distance away from the ST point, it can be useful to help you correctly position the ST point.

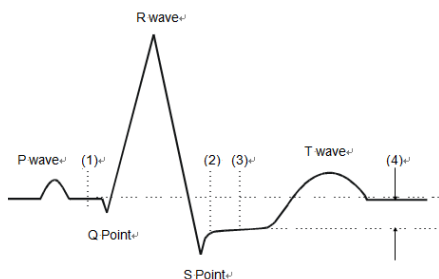

(1) ISO Baseline Point (2) J Point (3)ST Measurement Point (4) ST Value

8.7.9.2. Setting ST Point, J Point and ISO Point



CAUTION:

- When you start monitoring or the patient's heart rate or ECG waveform has obvious changes, it may affect the length of QT interval, thus affecting the position of ST points, so the positions of ISO and ST points need to be adjusted. Incorrect setting of ISO point or ST point may lead to false ST segment depression or elevation. Please always ensure that the location of ST measurement point is suitable for the patients under monitoring.

The steps for setting ST, J and ISO points are as follows:

1. Select ECG parameter area, waveform area, ST parameter area or ST waveform area to enter **【ECG】** menu.
2. Select **【ST】** submenu→ **【Adjust】** submenu.

3. Select **【ST Point】** to set the position of ST Point.

The setting of **【Auto Adjust】** defines the method of adjusting the ISO point and J point. When the **【Auto Adjust】** switch is turned on, the module automatically adjusts the positions of ISO and J points according to the current waveform. When the **【Auto Adjust】** switch is off, you can manually adjust the positions of **【ISO】** and **【J】** through “+” and “-”.

- ◆ The ISO point (isoelectric) position is given relative to the R-wave peak. Position the ISO point in the middle of the flattest part of the baseline (between the P and Q waves).
- ◆ The J point position is given relative to the R-wave peak and helps locating the ST point. Position the J point at the end of the QRS complex and the beginning of the ST segment.
- ◆ The ST point is located at a fixed distance relative to the J point, and the J point is moved so that the ST point is located in the middle of the ST segment. The ST point can be located at the positions of J+0, J+20, J+40, J+60, and J+80.

8.8. QT/QTc Monitoring

QT interval is the time from the beginning of QRS complex to the end of T wave, that is, the whole period of ventricular action potential depolarization (QRS interval) and repolarization phase (ST-T). QT test can help you to judge long QT interval syndrome.

QT interval is negatively correlated with heart rate. As heart rate increases, the QT interval shortens, while at lower heart rates QT interval gets longer. We can use several formulas to correct QT interval according to heart rate. The QT interval corrected by heart rate is called QTc.

8.8.1. QT/QTc measurement limitation

The following conditions may affect the accuracy of QT measurement:

- The amplitude of R wave is too low.
- Excessive ventricular heartbeat.
- RR interval is unstable.
- High heart rate causes P wave to invade the end of the previous T wave.

- T wave is too flat or t wave boundary is unclear.
- The existence of U wave makes the end of T wave difficult to define.
- QTc measurement is unstable.
- In the presence of noise, asystole, ventricular fibrillation, and ECG lead off.

In the above situation, you need to select leads with good T wave amplitude, no visible flutter, and no dominant U wave or P wave. In some cases, such as left and right bundle branch block or cardiac hypertrophy, QRS complex may widen. If a long QTc is observed, this should be confirmed to ensure that it is not caused by QRS broadening.

QT measurement cannot be performed in the presence of bigeminy rhythm because normal cardiac beats are not included in the analysis when they are followed by ventricular beats.

QT measurement cannot be performed when the heart rate is extremely high (over 180bpm). When the heart rate changes, it can take several minutes for the QT interval to stabilize. In order to obtain reliable QTc calculation results, it is important to avoid areas where the heart rate changes.

8.8.2. Enabling the QT/QTc Monitoring

QT/QTc monitoring function is off by default, and you need to turn it on before performing QT/QTc monitoring. Enable QT/QTc monitoring as follows:

1. Select ECG parameter area or waveform area to enter **【ECG】** menu.
2. Select **【QT】** submenu→**【Setting】** submenu.
3. Switch on **【QT Analysis】** .

8.8.3. Displaying QT/QTc Parameter

The method for displaying QT parameters and waveforms is as follows:

1. Enter the **【Screen Layout】** page in one of the following ways:
 - ◆ Select **【Screen Setup】** quick key→select **【Screen Layout】**submenu.
 - ◆ Select **【Main Menu】** quick key→from **【Display】** column to select **【Screen Layout】** .
2. Click on the location in the parameter area where QT parameters need to be displayed and select **【ECG】** → **【QT】** .



NOTE: QTc value is calculated based on QT-HR, not ECG-HR calculation leads. You can enter QT View to view QT-HR. For details, please refer to 8.8.4 Entering QT View.

The QT parameter area is displayed as follows. Depending on the settings, the display of your monitor may be different.

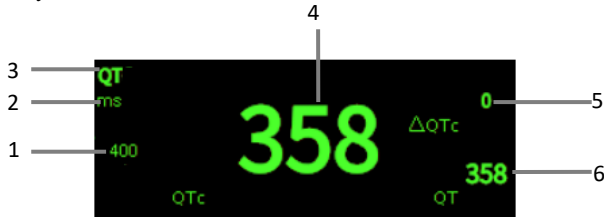

- (1) QTc alarm limit (if QTc alarm is off, the alarm off icon is displayed here)
- (2) Parameter Unit
- (3) Parameter Label
- (4) QTc value
- (5) Δ QTc value (the difference between the current value of QT_C and the baseline value; if Δ QTc alarm is off, the alarm off icon is displayed on the right side of the value)
- (6) QT value

8.8.4. Entering QT View

QT View displays the current QT parameter values and waveforms, as well as baseline/reference QT parameter values and waveforms. The steps to enter **【QT View】** are as follows:

1. Select QT parameter area to enter **【QT】** menu.
2. Select the **【QT View】** button at the bottom of the menu.

The following figure shows an example of QT View:

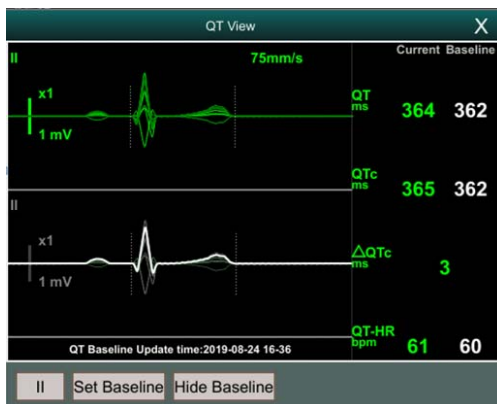

- ◆ The current waveform is displayed at the top of the view, and the color is the same as the ECG waveform, usually green.
- ◆ The baseline segment is displayed below in white.
- ◆ The starting point of QRS complex and the ending point of T wave are marked with vertical lines.
- ◆ In some cases, the algorithm may not be able to give QT measurement results because the waveform does not meet the requirements. At this time, the reason that cannot be analyzed will be displayed below the QT parameter area in QT View. In addition, a prompt message "QT cannot be analyzed" will be displayed in the technical alarm information area of the main interface.
- ◆ Select the lead label at the lower left of QT View, switch leads, and highlight the waveforms of the corresponding leads.

8.8.5. Setting the QT Baseline

Setting QT baseline is helpful to quantify QTc changes. After QT valid values appear, if you do not set QT baseline within 5 minutes, the monitor will automatically set QT baseline.

The steps for manually setting QT baseline are as follows:

1. Select the **【Set Baseline】** button below QT View.
2. Select **【OK】** in the pop-up dialog box to set the current QT parameter value as the baseline. The baseline value will be used to calculate the Δ QTc value. After the new QT baseline is set, the original baseline will be discarded. The

baseline will be cleared when the patient is released.

Select **【Show Baseline】** or **【Hide Baseline】** to show or hide QT baseline waveform.



CAUTION:

- Changing QT baseline will affect ΔQTc value and ΔQT alarm.

8.8.6. QT Setting

8.8.6.1. Setting the QT Alarm

QT alarm is set as follows:

1. Select QT parameter area to enter **【QT】** menu.
2. Select **【Alarm】** submenu.
3. Set properties of QTc and ΔQTc alarm.

8.8.6.2. Selecting QTc Formula

The monitor uses Hodges formula by default to correct QT interval according to heart rate. If you need to select other QTc formulas, the steps are as follows:

1. Select **【Main Menu】** quick key→from **【System】** column to select **【Maintenance】** →input maintenance password→Enter.
2. Select **【Module】** submenu→ **【ECG】** submenu.
3. Select **【QTc Formula】** .

◆ Hodges: $QTc = QT + 1.75 \times (\text{HeartRate} - 60)$

◆ Bazett: $QTc = QT \times \left(\frac{\text{Heart Rate}}{60}\right)^{\frac{1}{2}}$

◆ Fridericia: $QTc = QT \times \left(\frac{\text{Heart Rate}}{60}\right)^{\frac{1}{3}}$

◆ Framingham: $QTc = QT + 154 \times \left(1 - \frac{60}{\text{Heart Rate}}\right)$

8.9. Isoelectric Segments

Between the global onset and offset of the QRS-complex, signal parts with a duration of more than 6 ms and amplitudes not exceeding $20\mu\text{V}$ for at least three samples should be defined as isoelectric segments – I-wave before the global QRS-ONSET and K-wave after the global QRS-OFFSET.

Isoelectric parts (I-wave) after global QRS-ONSET or before global QRS-OFFSET (K-wave) are excluded in the duration measurement of the respective adjacent waveform.

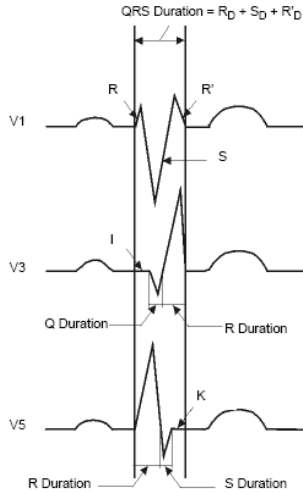

8.10. ECG Relearning

Changes in ECG templates may result in erroneous arrhythmia alarms or/and inaccurate heart rates.

The monitor provides ECG relearning function. ECG relearning enables the monitor to learn new ECG templates to correct arrhythmia alarms and heart rate values. After ECG relearning is completed, the monitor stores the QRS wave form obtained by learning as a template as the normal ECG wave form of the patient. During ECG monitoring, when you suspect abnormal arrhythmia alarm, you may need to start an ECG relearning.

8.11. Calibrating ECG

The ECG signal may be inaccurate due to hardware or software problems. As a result,

the ECG waveform amplitude becomes greater or smaller. In that case, you need to calibrate the ECG module. To do so, follow this procedure:

1. Select ECG parameter area or waveform area, set **【Filter Mode】** to **【Diagnose】**.
2. Select **【Main Menu】** quick key→from **【System】** column to select **【Maintenance】** →input maintenance password→Enter.
3. Select **【Module】** submenu→ **【ECG】** submenu.
4. Select **【Calibrate】**, the square wave signal will appear on the screen to compare the amplitude of the square wave with the scale. The error range should be within 5%. The ECG calibration must be completed by the maintenance personnel.

8.12. Defibrillation Synchronization

The module provides an analog out connector to output defibrillation synchronization signal. If a defibrillator is connected, it receives a synchronization pulse (100 ms, +5 V) through the analog out connector each time an R-wave is detected.

The steps to set defibrillation synchronization are as follows:

1. Select **【Main Menu】** quick key→from **【System】** column to select **【Maintenance】** →input maintenance password→Enter.
2. Select **【Module】** submenu→ **【Auxiliary Output】** submenu.
3. Set the defibrillation synchronization signal as needed.



CAUTION:

- **Improper use of a defibrillator may cause injury to the patient. The operator should determine whether to perform defibrillation or not according to the patient's condition.**
 - **According to AAMI specifications the peak of the synchronized defibrillator discharge should be delivered within 60 ms of the peak of the R-wave. The signal at the ECG output on the monitors is delayed by maximum of 25ms.**
-

8.13. ECG Troubleshooting

This section lists the problems that might occur. If you encounter problems when using the monitor or accessories, check the table below before requesting for services. If the problem persists after you have taken corrective actions, contact your service personnel.

Problem	Corrective Actions
Noisy ECG traces	<ol style="list-style-type: none"> 1. Check that clips are not detached. 2. Check that leadwires are not defective. Replace leadwires if necessary. 3. Check that patient cable or leadwires are routed too close to other electrical devices. Move the patient cable or leadwires away from electrical devices.
Excessive electro-surgical Interference	Use ESU-proof ECG cables.
Muscle Noise	<p>Inadequate skin preparation, tremors, tense subject, and/or poor clip placement.</p> <ol style="list-style-type: none"> 1. Perform skin preparation again and re-place the clips. For more information, see 8.4.1 Preparing the Patient Skin 2. Avoid muscular areas.
Intermittent Signal	<ol style="list-style-type: none"> 1. Check that cables are properly connected. 2. Check that clips are not detached. Perform skin preparation again as described in 8.4.1 Preparing the Patient Skin. 3. Check that the patient cable or leadwires are not damaged. Change them if necessary.
Excessive alarms: heart rate, lead fault	<ol style="list-style-type: none"> 1. Check that clips are not detached. Perform skin preparation again and replace the clips. For more information, see 8.4.1 Preparing the Patient Skin. 2. Check for excessive patient movement or muscle tremor. Reposition the clips.
Low Amplitude ECG Signal	<ol style="list-style-type: none"> 1. Check that the ECG gain is not set too low. Adjust the gain as required. For more information, see 8.5.5 Setting ECG Waveforms. 2. Perform skin preparation again and re-place the clips. For more information, see 8.4.1 Preparing the Patient Skin. 3. Check clip application sites. Avoid bone or muscular area.

Problem	Corrective Actions
	4. Check that clips are not dry or used for a prolonged time.
No ECG Waveform	1. Check that the ECG gain is not set too low. Adjust the gain as required. For more information, see 8.5.5 Setting ECG Waveforms . 2. Check that the leadwires and patient cables are properly connected. Change cable and leadwires. 3. Check that the patient cable or leadwires are not damaged. Change them if necessary.
Base Line Wander	1. Check for excessive patient movement or muscle tremor. Secure leadwires and cable. 2. Check that clips are not detached. For more information, see 8.4.1 Preparing the Patient Skin . 3. Check for ECG filter setting. Set ECG Filter mode to 【Monitor】 .



NOTE: Physiological alarm and technical alarm information refer to *D Alarm Information*.

Chapter 9 Respiration Rate (RESP)

9.1. Introduction

Impedance respiration is measured across the thorax. When the patient is breathing, the volume of air changes in the lungs, resulting in impedance changes between the electrodes. Respiration rate (RR) is calculated from these impedance changes, and a respiration waveform appears on the monitor screen.

9.2. Safety Information



WARNING:

- **If you do not set the detection level for the respiration correctly in manual detection mode, it may not be possible for the monitor to detect apnea. If you set the detection level too low, the monitor is more likely to detect cardiac activity, and to falsely interpret cardiac activity as respiratory activity in the case of apnea.**
 - **The respiration measurement does not recognize the cause of apneas. It only indicates an alarm if no breath is detected when a pre-adjusted time has elapsed since the last detected breath. Therefore, it cannot be used for diagnostic purpose.**
 - **If operating under conditions according to the EMC Standard IEC 60601-1-2 (Radiated Immunity 3V/m), field strengths above 3V/m may cause erroneous measurements at various frequencies. Therefore, it is recommended to avoid the use of electrically radiating equipment in close proximity to the respiration measurement unit.**
 - **The impedance respiration measurement may cause rate changes in Minute Ventilation Rate Responsive Pacemakers. Set the pacemaker rate responsive mode off or disable the impedance respiration measurement on the monitor.**
 - **When using the electrosurgery unit, ensure proper contact of the ESU return electrode to the patient to avoid burns at monitor measurement sites. Also ensure that the ESU return electrode is near the operating area.**
-

**CAUTION:**

- Only use parts and accessories specified in this manual, and obey all warnings and cautions.
- Respiration monitoring is not for use on the patients who are very active, as this will cause false alarms.

9.3. RESP Display

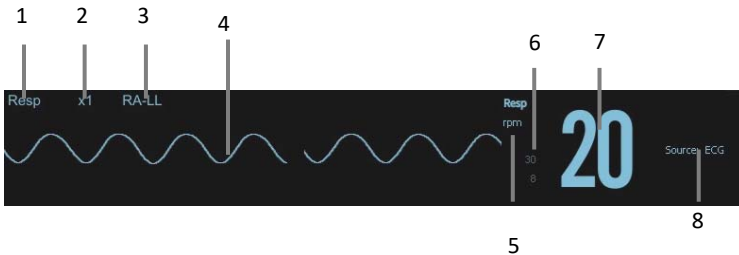

- | | |
|--|------------------------|
| (1) Parameter label | (2) RESP waveform gain |
| (3) RESP lead | (4) Resp waveform |
| (5) RR unit | |
| (6) RR Alarm limits: If the respiration rate is turned off, the alarm off icon will be displayed here. | |
| (7) RR value | (8) RR source |

9.4. Placing RESP Electrodes

As the Respiration measurement adopts the standard ECG electrode placement, you can use different ECG cables. Since the respiration signal is measured between two ECG electrodes, if a standard ECG electrode placement is applied, the two electrodes should be RA and LA, or RA and LL.

For more information, see *8.4.2 Applying Electrodes*.

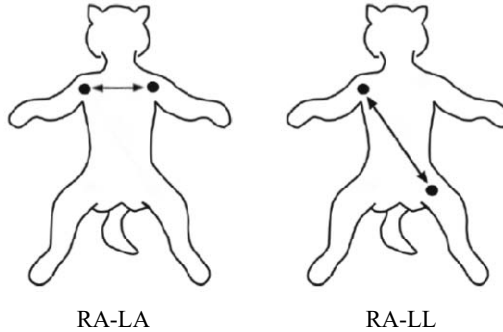

CAUTION:

- **Correct electrodes placement can help to reduce cardiac overlay: avoid the liver area and the ventricles of the heart in the line between the respiratory electrodes.**
 - **Some patients with restricted movements breathe mainly abdominally. In these cases, you may need to place the left leg electrode on the left abdomen at the point of maximum abdominal expansion to optimize the respiratory wave.**
 - **In clinical applications, some patients expand their chests laterally, causing a negative intrathoracic pressure. In these cases, it is better to place the two respiration electrodes in the right midaxillary and the left lateral chest areas at the patient's maximum point of the breathing movement to optimize the respiratory waveform.**
 - **Regularly inspect the electrode application site to ensure skin quality. If there are signals of allergies, change the clip application site.**
-

9.4.1. Optimizing Lead Placement for Resp

If you want to measure Resp and you are already measuring ECG, you may need to optimize the placement of the two electrodes between which Resp will be measured. Repositioning ECG electrodes from standard positions results in changes in the ECG waveform and may influence ST and arrhythmia interpretation.

9.4.2. Cardiac Overlay

Cardiac activity that affects the Resp waveform is called cardiac overlay. It happens when the Resp electrodes pick up impedance changes caused by the rhythmic blood flow. Correct electrodes placement can help to reduce cardiac overlay: avoid the liver area and the ventricles of the heart in the line between the respiratory electrodes.

9.4.3. Abdominal Breathing

Some patients with restricted movement breathe mainly abdominally. In these cases, you may need to place the left leg electrode on the left abdomen at the point of maximum abdominal expansion to optimise the respiratory wave.

9.4.4. Lateral Chest Expansion

In clinical applications, some patients expand their chests laterally, causing a negative intrathoracic pressure. In these cases, it is better to place the two respiration electrodes in the right midaxillary and the left lateral chest areas at the patient's maximum point of the breathing movement to optimize the respiratory waveform.

9.5. RESP Settings

9.5.1. Setting the RESP Alarm

To set the RESP alarm properties, follow this procedure:

1. Select the Resp parameter area or waveform area to enter the **【RESP】** menu.
2. Select **【Alarm】** submenu.
3. If the alarm setting is protected by password, enter the password. For detail, please refer to *7.6.2 Changing Alarm Setup Protection Mode*.
4. Set alarms as needed.

9.5.2. Selecting RR Source

You can select RR source, follow this procedure:

1. Select the RESP parameter area or waveform area to enter the **【RESP】** menu.
2. Select **【Setup】** submenu.

3. Set **【RR Source】**. When you select **【Auto】**, the system automatically selects the RR source according to the priority. RR source is first CO₂, and then ECG, and SpO₂. When the current RR source does not have valid measurement, the system automatically switches the **【RR Source】** to **【Auto】** .

9.5.3. Selecting Respiration Lead

You can set up respiration lead to get the best respiratory waveform. The steps to set up breathing leads are as follows:

1. Select the RESP parameter area or waveform area to enter the **【RESP】**menu.
2. Select **【Setup】** submenu.
3. Set **【RESP Lead】**. If the respiratory waveform is still poor after adjusting the respiration lead or the respiration rate measurement is suspected to be inaccurate, you can adjust the electrode position.

9.5.4. Setting RESP Waveform Gain

You can adjust the RESP waveform gain to better view the waveform amplitude. The steps to set the RESP waveform gain are as follows:

1. Select the RESP parameter area or waveform area to enter the **【RESP】**menu.
2. Select **【Setup】** submenu.
3. Set **【Gain】** .

9.5.5. Setting the RESP Waveform Speed

To set the RESP waveform speed, follow this procedure:

1. Select the RESP parameter area or waveform area to enter the **【RESP】**menu.
2. Select **【Setup】** submenu.
3. Set **【Wave Speed】** .

9.5.6. Setting the Auto Detection Switch

To set the auto detection switch, follow this procedure:

1. Select the RESP parameter area or waveform area to enter the **【RESP】**menu.

2. Select **【Setup】** submenu.
3. Switch on or off **【Auto Threshold Detection】** .
 - If **【 Auto Threshold Detection 】** is switched on, the monitor automatically adjusts the RESP waveform detection level, or threshold.
 - **【Auto Threshold Detection】** is switched off, you have to manually adjust the RESP waveform threshold. For more information, see *9.5.7. Manually Adjust the RESP Waveform Detection Threshold.*

9.5.7. Manually Adjust the RESP Waveform Detection Threshold

Use the manual detection mode in the following situations:

- ◆ The respiration rate and the heart rate are close.
- ◆ Patients have intermittent mandatory ventilation.
- ◆ Respiration is weak. Try repositioning the electrodes to improve the signal.

To set the Resp waveform threshold to the desired level, follow this procedure:

1. Select the RESP parameter area or waveform area to enter the **【RESP】**menu.
2. Select **【Threshold】** submenu.
3. Select the up and down arrows below **【Threshold】** to define the Resp waveform threshold. Once set, the detection level will not adapt automatically to different respiration depths. It is important to remember that if the depth of breathing changes, you may need to change the detection level.

9.6. RESP Troubleshooting

For more information, see *D Alarm Information*

Chapter 10 SpO2

10.1. Introduction

Pulse Oxygen Saturation (SpO₂) monitoring is a non-invasive technique used to measure the amount of oxygenated haemoglobin and pulse rate by measuring the absorption of selected wavelengths of light. The light generated in the emitter side of the probe is partly absorbed when it passes through the monitored tissue. The amount of transmitted light is detected in the detector side of the probe. When the pulsative part of the light signal is examined, the amount of light absorbed by the haemoglobin is measured and the pulse oxygen saturation can be calculated. This device is calibrated to display functional oxygen saturation.

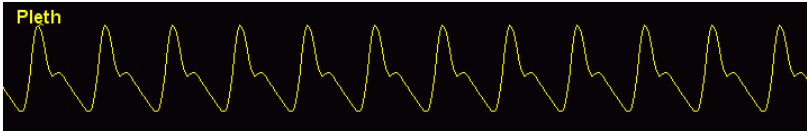

◆ Parameter Display

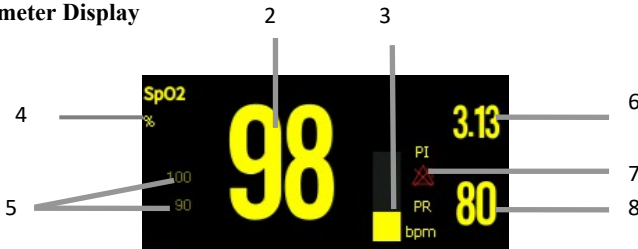

- (1) Pleth waveform (Pleth): The amplitude of the waveform can directly reflect the strength of the patient's pulse signal. The waveform is not normalized.
- (2) SpO₂ value: Percentage of oxygenated hemoglobin in relation to the sum of oxyhemoglobin and deoxyhemoglobin.
- (3) Pleth bar: Proportional to the intensity of the pulse.
- (4) SpO₂ unit
- (5) SpO₂ alarm limits: If the SpO₂ alarm is turned off, the alarm off icon is displayed here.
- (6) Perfusion index (PI): Applicable for SpO₂ module. Gives the numerical value for the pulsatile portion of the measured signal caused by arterial pulsation. PI indicates

the signal strength of SpO2 and also partially indicates the signal quality.

- ◆ Above 1 is optimal;
 - ◆ Between 0.3 and 1 is acceptable;
 - ◆ Below 0.3 indicates low perfusion. If the PI is less than 0.3, the low perfusion status is indicated (alternating with a question mark for SpO2 measurements), indicating that the SpO2 measurements may be inaccurate. Reposition the SpO2 sensor or find a better site. If low perfusion persists, choose another method to measure oxygen saturation if possible.
- (7) Pulse rate (PR) alarm off icon: pulse rate alarm is turned off.
- (8) Pulse rate: the number of pulses detected per minute (from the pleth waveform)

10.2. Safety Information



WARNING:

- **Use only SpO2 sensors specified in this manual. Follow the SpO2 sensor's instructions for use and adhere to all warnings and cautions.**
 - **Before use, the operator needs to verify the compatibility between the monitor, probe and cable. Otherwise, it may cause injury to the patient.**
 - **When a trend toward patient deoxygenation is indicated, analyze the blood samples with a laboratory co-oximeter to completely understand the patient's condition.**
 - **Do not use SpO2 sensors during magnetic resonance imaging (MRI). Induced current could potentially causes burns. The sensor may affect the MRI image, and the MRI unit may affect the accuracy of the oximetry measurements.**
 - **Prolonged continuous monitoring may increase the risk of undesirable changes in skin characteristics, such as irritation, reddening, blistering or burns. Inspect the sensor site every 2 hours and move the sensor if the skin quality changes. Change the application site every 4 hours. For patients with poor peripheral blood circulation or sensitive skin, inspect the sensor site more frequently.**
 - **Functional testers cannot be used to evaluate the accuracy of pulse oximetry probes and pulse oximetry monitors.**
-



CAUTION:

- **Use only specified accessories in this manual. Follow the instructions for use and adhere to all warnings and cautions.**
-

10.3. Monitoring Procedure

1. Selecting SpO₂ Sensor

Depending on the animal category, weight and application site, you can select the SpO₂ sensor as required.

2. Connecting SpO₂ Sensor

Plug the SpO₂ sensor cable into the SpO₂ connector on the measurement module.

3. Applying SpO₂ Sensor

Place the sensor on the animal's tongue or ear. For dogs, cats and equines, place the sensor on their tongue. When placing the sensor, place the optical part of the sensor in the center of the tongue. You can also place the sensor on the animal's lips, toes, ears, prepuce and vulva.



CAUTION:

- **Do not apply sensor too tightly as this results in venous pulsation which may severely obstruct circulation and lead to inaccurate measurements.**
 - **At elevated ambient temperatures be careful with measurement sites that are not well perfused, because this can cause burns after prolonged application.**
 - **Avoid placing the sensor on extremities with an arterial catheter, an NIBP cuff or an intravascular venous infusion line.**
-

10.4. Setting SpO₂

10.4.1. Setting SpO₂ Alarm

To change the SpO₂ alarm settings, follow this procedure:

1. Select the SpO2 parameter area or waveform area to enter the **【SpO2】** menu.
2. Select **【Alarm】** submenu.
3. If the alarm setting is protected by password, enter the password. For detail, please refer to **7.6.2 Changing Alarm Setup Protection Mode**.
4. Set alarms as needed.

10.4.2. Setting Sensitivity

The SpO2 value displayed on the monitor screen is the average of data collected within a specific time. The shorter the averaging time is, the quicker the monitor responds to changes in the patient's oxygen saturation level. Contrarily, the longer the averaging time is, the slower the monitor responds to changes in the patient's oxygen saturation level, but the SpO2 measurement is more stable. For critically ill patients, selecting shorter averaging time will help understanding the patient's state.

To set the averaging time, follow this procedure:

1. Select the SpO2 parameter area or waveform area to enter the **【SpO2】** menu.
2. Select **【SpO2 Setup】** submenu.
3. Select **【Sensitivity】** and then toggle between **【High】**, **【Med】** or **【Low】**.

10.4.3. Setting NIBP measurement on the same limb

When monitoring SpO2 and NIBP on the same limb simultaneously, you can switch on **【NIBP Simul】** to lock the SpO2 alarm status until the NIBP measurement ends. If you switch off **【NIBP Simul】**, low perfusion caused by NIBP measurement may lead to inaccurate SpO2 readings and therefore cause false physiological alarms.

To set the **【NIBP Simul】**, follow this procedure:

1. Select the SpO2 parameter area or waveform area to enter the **【SpO2】** menu.
2. Select **【Alarm】** submenu.
3. Set **【NIBP Simul】** as to **【On】** or **【Off】**.

10.4.4. Changing the Speed of Pleth Waveform

To set the sweep speed of Pleth waveforms, follow this procedure:

1. Select the SpO2 parameter area or waveform area to enter the **【SpO2】** menu.

2. Select **【SpO2 Setup】** submenu.
3. Set **【Wave Speed】** to the appropriate value. The larger the value, the faster the scanning speed and the wider the waveform.

10.4.5. Setting Pitch Tone

The pitch tone function is on by default. The steps to turn off the pitch tone function are as follows:

1. Select the SpO2 parameter area or waveform area to enter the **【SpO2】** menu.
2. Select **【SpO2 Setup】** submenu.
3. Switch off **【Pitch Tone】** .

10.4.6. Setting PI Display

You can switch on or off PI display by following these steps:

1. Select the SpO2 parameter area or waveform area to enter the **【SpO2】** menu.
2. Select **【SpO2 Setup】** submenu.
3. Set **【Display PI】** as to **【On】** or **【Off】** .

10.5. Setting PR

10.5.1. Setting PR Alarm

You can set PR alarm by following these steps:

1. Select the SpO2 parameter area or waveform area to enter the **【SpO2】** menu.
2. Select **【PR Alarm】** submenu.
3. Set alarms as needed.

10.5.2. Setting QRS Volume

If the alarm source is set to PR, the QRS tone is derived from PR measurements. To set the QRS volume, follow this procedure:

1. Select the SpO2 parameter area or waveform area to enter the **【SpO2】** menu.
2. Select **【PR Setup】** submenu.
3. Set **【QRS Volume】** to the appropriate value.

If the SpO2 value is effective, the monitor also adjusts the QRS tone (Pitch tone)

according to the SpO₂ value. For information, see *10.5.5 Setting Pitch Tone*.

10.5.3. Setting PR Source

Current pulse source is displayed in the PR parameter area. The PR from current pulse source has the following characteristics:

- PR is monitored as system pulse and generates alarms when you select PR as the active alarm source;
- PR is stored in the monitor's database and reviewed in the graphic/tabular trends; in trend graphs, as the PR curve is in the same color with that of the PR source, it is unlikely to distinguish the PR source.

To set which pulse rate as PR source, follow this procedure:

1. Select the SpO₂ parameter area or waveform area to enter the **【SpO₂】** menu.
2. Select **【PR Setup】** submenu.
3. Select **【PR Source】**, and select a suitable PR source in the drop-down list.

The drop-down list of **【PR Source】** displays the currently valid PR source from top to bottom according to the priority level. When you select **【Auto】**, the system will automatically select the first option in the list as the PR source. If the PR source you set does not exist, the system will automatically switch **【PR Source】** to **【Auto】**. When you select **【IBP】**, the system will automatically use the first pressure label in the list as the PR source.

10.6. SpO₂ Measurement Limitations

If you doubt the SpO₂ measurements, check the patient's vital signs first, then check the monitor and SpO₂ sensor. The following factors may influence the accuracy of measurements:

- There is excessive illumination from light sources such as a surgical lamp, a bilirubin lamp, or sunlight;
- Excessive patient movement;
- Diagnostic test;
- Low perfusion;
- Electromagnetic interference, such as MRI device;
- Electrosurgical equipment;

- Concentration of nonfunctional hemoglobin, such as carbonyl hemoglobin (COHb) and methemoglobin(MetHb);
- The presence of certain dyes, such as methylene blue or indigo carmine;
- Improper placement or incorrect use of pulse oximeter probe;
- Shock, anemia, hypothermia or use of vasoconstrictor drugs, which can cause blood flow in the arteries to drop to unmeasurable levels.

Chapter 11 Temperature (TEMP)

11.1. Introduction

The thermistor is applied on continuous temperature measurement, which is based on the principle that electrical resistance of the thermistor changes as temperature changes. Thermistors measure the resistance change and use it to calculate the temperature.

Depending on the model of the different monitors you are using, you can measure the body temperature of up to two temperature sites and calculate the difference between two measured sites (ΔT).

Measuring mode is direct mode.

11.2. Displaying the TEMP Parameter Area

To display the Temp parameters area, follow this procedure:

1. Enter **【Screen Layout】** interface in either of the following ways:
 - ◆ Select **【Screen Setup】** quick key→Select **【Screen Layout】** submenu.
 - ◆ Select **【Main Menu】** quick key→from **【Display】** column to select **【Screen Layout】**.
2. Select you want to display the parameter area of the temperature parameters, and then from the popup list select **【TEMP】**.

11.3. TEMP Display

The following figure shows the TEMP parameter area for temperature monitoring. Your display may be configured to look different.

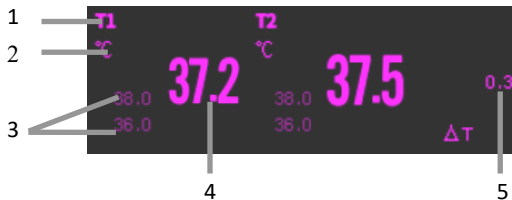

(1) Parameter label

(2) TEMP unit

(3) TEMP alarm limits: If TEMP alarm is turned off, the alarm closing icon is displayed

here.

(4) TEMP value

(5) TEMP Difference (ΔT): TEMP Difference between two temperature sites. It displays only when ΔT is switched on.

11.4. Preparing for TEMP Monitoring

Please follow these steps to prepare TEMP measurement:

1. According to the type of patient and the measurement site, select the appropriate temperature probe.
2. Insert the probe or extension cable into the temperature probe connector. If a disposable probe is used, connect the probe and extension cable.
3. Attach the probe to the patient correctly.
4. Select an appropriate temperature label.

11.5. TEMP Settings

11.5.1. Setting TEMP Alarm

To set the temperature alarm, follow this procedure:

1. Select the TEMP parameter area to enter the **【TEMP】** menu.
2. Select **【Alarm】** submenu.
3. If the alarm setting is protected by password, enter the password. For detail, please refer to *7.6.2 Changing Alarm Setup Protection Mode*.
4. Set alarms as needed.

11.5.2. Setting TEMP Label

Select the temperature label according to the measurement site. To do so, follow this procedure:

1. Select the TEMP parameter area to enter the **【TEMP】** menu.
2. Select **【Setup】** submenu.
3. Set the TEMP label name according to the measurement site.

11.5.3. Displaying the Temperature Difference

To display the temperature difference between two measurement sites monitored by the same temperature module, switch on corresponding ΔT . To do so, follow this procedure:

1. Select the TEMP parameter area to enter the **【TEMP】** menu.
2. Select **【Setup】** submenu.
3. Switch on ΔT .

11.5.4. Setting TEMP Unit

You can change the unit of TEMP by following the steps below:

1. Select the TEMP parameter area to enter the **【TEMP】** menu.
2. Select **【Setup】** submenu.
3. Set TEMP **【Unit】** .

11.6. TEMP Troubleshooting

This section lists the problems that might occur. If you encounter the problems when using the equipment or accessories, check the table below before requesting for services. If the problem persists, contact your service personnel.



NOTE: For the physiological and technical alarm messages, see *D Alarm Information*.

Problem	Corrective Actions
Do not display TEMP parameter area on the main screen.	<ol style="list-style-type: none"> 1. Check if the display of the TEMP parameter is set in 【Screen Setup】 menu. 2. Check that if the TEMP parameter switch is enabled. For more information, see <i>3.6.1 Setting Parameters</i>. 3. Check that if the connections of the temperature probe and the extension cable are tight.
Measurement fails / "--" is	<ol style="list-style-type: none"> 1. If you are using a disposable probe, check whether the

S12 Vet Monitor User's Manual

Problem	Corrective Actions
displayed in the Temp parameter area.	probe is tightly connected to the extension cable. 2. Try using a known good probe in case the sensor is damaged

Chapter 12 NIBP

12.1. Introduction

The monitor uses the oscillometric method for measuring the non-invasive blood pressure (NIBP). NIBP measurement is based on the principle that pulsatile blood flow through an artery creates oscillations of the arterial wall. The oscillometric device uses a blood pressure cuff to sense these oscillations that appear as tiny pulsations in cuff pressure. The oscillometric devices measure the amplitude of pressure changes in the occluding cuff as the cuff deflates from above systolic pressure. The amplitude suddenly increases as the pulse breaks through the occlusion in the artery. As the cuff pressure decreases further, the pulsations increase in amplitude, reach a maximum (which approximates to the mean pressure), and then diminish. The oscillometric method measures the mean pressure and determines the systolic and diastolic pressures.



NOTE:

- **Blood pressure measurements determined with this device are equivalent to those obtained by a trained observer using the cuff/stethoscope auscultatory method or an intra-arterial blood pressure measurement device, within the limits prescribed by IEC 80601-2-30.**
- **NIBP measurement can be performed during electro-surgery and discharge of defibrillator.**

12.2. Safety Information



WARNING:

- **Be sure to select the correct patient category setting for your patient before NIBP measurement.**
- **Do not measure NIBP on patients with sickle-cell disease or on the limb where skin damage has occurred or is expected.**
- **Use clinical judgment to determine whether to perform frequent automatic**

blood pressure measurements on patients with severe blood clotting disorders because of the risk of hematoma in the limb fitted with the cuff.

- Do not use the NIBP cuff on a limb with an intravenous infusion or arterial catheter in place. This could cause tissue damage around the catheter when the infusion is slowed or blocked during cuff inflation.
- Continuous cuff pressure due to connection tubing kinking may cause blood flow interference, and resulting in harmful injury to the patient.
- NIBP reading can be affected by the measurement site, the position of the patient, exercise, or the patient's physiologic condition. If you doubt the NIBP measurements, determine the patient's vital signs by alternative means, and then verify that the monitor is working correctly.
- Devices that exert pressure on tissue have been associated with purpura, ischemia, and neuropathy. Inspect the application site regularly to ensure skin quality and inspect the extremity of the cuffed limb for normal color, warmth and sensitivity. If the skin quality changes, or if the extremity circulation is being affected, move the cuff to another site or stop the blood pressure measurements immediately. Check more frequently when making automatic or STAT measurements. Auto NIBP measurements with one and two minute intervals are not recommended for extended periods of time.
- NIBP diagnostic significance must be decided by the physician.
- As the monitor uses an alternative small-bore connector design different from those specified in the ISO 80369 series, there is a possibility that a misconnection can occur between the monitor and a medical device using a different alternative small-bore connector, which can result in a hazardous situation causing harm to the patient. Special measures need be taken by the user to mitigate these reasonable foreseeable risks.



CAUTION:

- Only use parts and accessories specified in this manual. Follow the instructions for use and adhere to all warnings and cautions.
- Accuracy of NIBP measurement depends on using a cuff of proper size. It is essential to measure limb circumference and choose a cuff with proper size.

- **NIBP automatically calibrated every time when the monitor is turned on. If it is not turned off for a long time or if the pressure is not accurate during use, you can use the “Reset” function in the NIBP menu to calibrate. You need to remove the cuff and windpipe before calibration, which in order to connect the NIBP pressure sensor to the atmosphere.**
-

12.3. NIBP Measurement Limitations

Measurements are impossible with heart rate extremes of less than 40bpm or greater than 240bpm, or if the patient is on a heart-lung machine. The measurement may be inaccurate or impossible in the following situations:

- Regular arterial pressure pulses are hard to detect;
- With excessive and continuous patient movement such as shivering or convulsions;
- With cardiac arrhythmias;
- With rapid blood pressure changes;
- With severe shock or hypothermia that reduces blood flow to the peripheries;
- On an edematous extremity;

12.4. Measurement Modes

The monitor has the following NIBP measurement modes:

- **Manual:** Manually start a NIBP measurement.
- **Auto:** The monitor automatically and repeatedly performs NIBP measurements at set intervals.
- **STAT:** With 5 minutes, the measurement is continuously performed, and then the monitor returns to the original mode.
- **Sequence:** The monitor measures automatically according to the set cycle length and interval.

12.5. NIBP Display

The NIBP display shows only numerics.

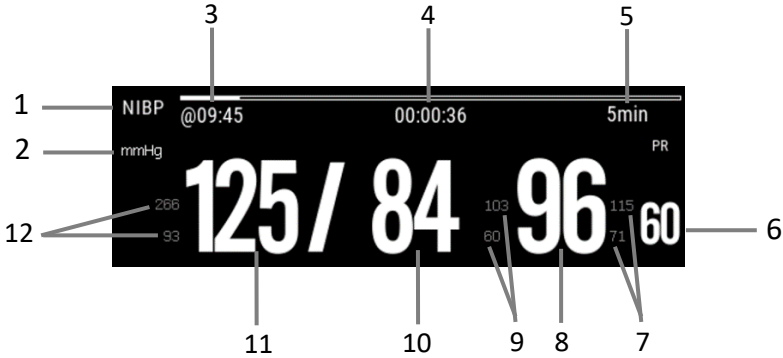

- (1) Parameter Label
- (2) NIBP Unit: mmHg or kPa
- (3) The last NIBP measurement time
- (4) Time to the next measurement (for Auto mode and Sequence only).
- (5) Measurement mode: The measurement interval time is displayed during Auto NIBP measurement, and the current measurement period and measurement interval time are displayed during Sequence measurement.
- (6) Pulse rate: the number of pulses detected per minute (from the pressure waveform of cuff)
- (7) Mean pressure alarm limit
- (8) Mean pressure (displayed after measurement completed) or cuff pressure (displayed during the measurement)
- (9) Diastolic pressure alarm limit
- (10) Diastolic pressure
- (11) Systolic pressure
- (12) Systolic pressure alarm limit



NOTE:

- If NIBP measurement fails, "XX" is displayed; if NIBP measurement is not

taken, "--" is displayed

- **Outlined NIBP numerics indicate that the measurement exceeds the set time. So these NIBP values are not recommended for reference.**
-

12.6. Preparing for NIBP Measurements

1. Verify that the patient category setting is correct.
2. Connect the airpipe to the NIBP cuff connector of the device.
3. Select an appropriately sized cuff for the patient, and then apply it as follows:
 - a) Determine the patient's limb circumference.
 - b) Select an appropriate cuff by referring to the limb circumference marked on the cuff. The width of the cuff should be 50% of the limb circumference, or 2/3 of the length of the upper arm. The inflatable part of the cuff should be long enough to encircle at least 50% to 80% of the limb.
 - c) Apply the cuff to the patient's upper arm or leg and make sure the Φ marking on the cuff matches the artery location. Do not wrap the cuff too tightly around the limb. Otherwise it may cause discoloration and ischemia of the extremities. Make sure that the cuff index line falls within the range markings on the cuff. If it does not, use a larger or smaller cuff that will fit better.
 - d) Middle of the cuff should be at the level of the right atrium of the heart.
4. Connect the cuff to the air tubing. Avoid compression or restriction of pressure tubes. Air must pass unrestricted through the tubing.



CAUTION:

- **A wrong cuff size and a folded or twisted bladder can cause inaccurate measurements.**
- **Do not touch or apply external pressure against the cuff and air tubing during NIBP measurement. This may cause inaccurate blood pressure values.**
- **Use care when placing the cuff on an extremity used for monitoring other patient parameters. Pressurization of the cuff may temporarily cause loss of**

function of simultaneously used monitoring equipment on the same limb.

Details about the cuff sites on different animals are as follows.

■ Cuff placement for a cat

A cat may be left in its owner's lap to keep it calm. Measurements are best done in an area of the hospital away from noise and bright lights. The animal may be held so that the front limbs are free for cuff placement. In conscious animals, the tail may be the most appropriate location for placement of the cuff. Cats may be most comfortable in sternal recumbency making the tail a more preferable site.

For the median artery on the foreleg, place the cuff around the forelimb, between the elbow and carpus. It is not necessary to center the cuff over the artery which is on the medial side of the leg because of the fully encircling bladder design. Hair need not be clipped except when heavily matted. In cats less than five pounds when measurements are difficult to obtain, place the cuff around the leg above the elbow to obtain measurements from the brachial artery. Measurements from the coccygeal artery may be used by placing the cuff around the base of the tail but not in anesthetized animals.

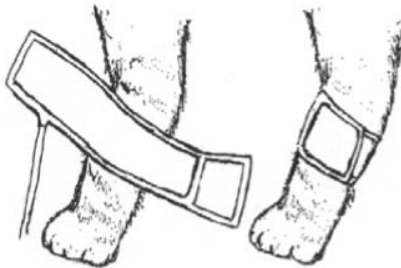

Cat cuff placement

■ Cuff placement for a dog

For measurements in dogs, it is preferable to use the right lateral, sternal or dorsal recumbent positions. That is not a problem in anesthetized animals, but it may be difficult to get large dogs to cooperate for proper positioning. If the dog is in a sitting position, place the front paw on the operator's knee and take measurements from the metacarpus.

Sites for cuff placement are the metacarpus, metatarsus and anterior tibial. In anesthetized animals, most surgeries are done on the posterior part of the body so the metacarpal area of the forelimb is most convenient. In situations where this is not possible,

the cuff should be wrapped around the metatarsus just proximal to the tarsal pad or around the hind leg just distal to the hock. The tail site should not be used for cuff placement during anesthesia.

It is not necessary to center the cuff over the artery because of the fully encircling bladder design. If the hair over the artery site is too thick or matted for good contact, it should be clipped.

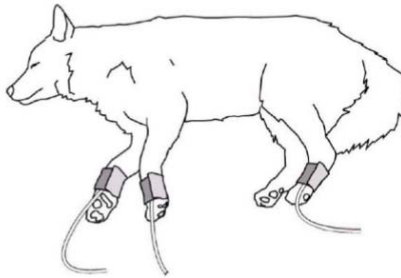

dog cuff placement





■ Other big animals





A big animal such as a horse should be in a stock, standing still, or lying down.

For horses and cows, the cuff can be wrapped around the base of the tail using the coccygeal artery on the ventral surface.

12.7. Starting and Stopping NIBP Measurements

Start and stop NIBP measurement by selecting the NIBP quick key keys or from the NIBP menu:

Task	Via quick key	Via NIBP menu
Start a manual measurement	Select 【NIBP Start/Stop】 quick key 	Select 【Start】
NIBP Auto measurement	Select 【NIBP Measure】 quick key  → Select interval time	Select 【Setup】 submenu → set 【Interval Time】
NIBP Sequence measurement	Select 【NIBP Measure】 quick key  → Select 【Sequence】 → Select 【NIBP Start/Stop】 quick key 	Select 【Sequence】 submenu → set NIBP Sequence measurement → Select 【Start】

Task	Via quick key	Via NIBP menu
Start STAT measurement	Select 【NIBP STAT】 quick key 	Select 【STAT】
Stop the current NIBP measurements	Select 【NIBP Start/Stop】 quick key 	Select 【Stop】
End Auto NIBP or Sequence measurement	Select 【NIBP Stop All】 quick key 	Select 【Stop All】
Stop STAT measurement	Select 【NIBP Start/Stop】 quick key 	Select 【Stop】 or 【Stop All】

12.8. NIBP Settings

12.8.1. Setting the NIBP Alarm

To set the NIBP alarm properties, follow this procedure:

1. Select the NIBP parameter area to enter the **【NIBP】** menu.
2. Select **【Alarm】** submenu.
3. If the alarm setting is protected by password, enter the password. For detail, please refer to **7.6.2 Changing Alarm Setup Protection Mode**.
4. Set alarms as needed.

12.8.2. Setting the Initial Cuff Inflation Pressure

You can manually set the initial inflation pressure of the cuff, follow this procedure:

1. Select the NIBP parameter area to enter the **【NIBP】** menu.
2. Select **【Setup】** submenu.
3. Set **【Initial Pressure】** : Select the appropriate cuff pressure value as needed.

12.8.3. Setting the NIBP Interval

For Auto NIBP measurement, you need to set the interval between two NIBP measurements. To set the NIBP interval, follow this procedure:

1. Select the NIBP parameter area to enter the **【NIBP】** menu.
2. Select **【Setup】** submenu.

3. Set **【Interval Time】** .

12.8.4. Selecting NIBP Start Mode

Start mode defines how NIBP auto mode works. To set the **【Start Mode】** , follow this procedure:

1. Select the NIBP parameter area to enter the **【NIBP】** menu
2. Select **【Setup】** submenu.
3. Set **【Start Mode】** .

◆ **【Clock】** : After the first measurement, the monitor automatically synchronizes NIBP automatic measurements with the real time clock. For example, if **【Interval】** is set to **【30min】**, and you start NIBP auto measurement at 10:03, the next measurement will be taken at 10:30, and then at 11:00, 11:30, and so on.

◆ **【Interval】** : After the first measurement, the monitor automatically repeats measurements at set interval. For example, if **【Interval】** is set to **【30min】** , and you start NIBP auto measurement at 10:03, the next measurement will be taken at 10:33, and then at 11:03, 11:33, and so on.

12.8.5. Enabling the NIBP End Tone

The monitor can issue a reminder tone at the completion of NIBP measurement. The NIBP End Tone is off by default. To switch on the NIBP end tone, follow this procedure:

1. Select the NIBP parameter area to enter the **【NIBP】** menu
2. Select **【Setup】** submenu.
3. Switch on **【NIBP End Tone】** .

12.8.6. Setting NIBP Sequence Measurement

NIBP sequence measurements can consist of up to 5 measurement periods: A, B, C, D, and E. You can set the measurement duration for each period and the interval between NIBP measurements in each period separately. The steps to set up the NIBP measurement sequence are as follows:

1. Select the NIBP parameter area to enter the **【NIBP】** menu.
2. Select **【Sequence】** submenu.
3. Set each sequence measurement to **【Duration】** or **【Interval Time】** separately.

12.8.7. Setting NIBP Unit

You can change the NIBP units by following these steps:

1. Select the NIBP parameter area to enter the **【NIBP】** menu.
2. Select **【Setup】** submenu.
3. Set NIBP **【Unit】** .

12.8.8. Setting NIBP Invalid Time

NIBP measurements become outline fonts after a preset time. This avoids older NIBP values being misinterpreted as current measurements. To set the timeout period, follow this procedure:

1. Select **【Main Menu】** quick key→from **【System】** column to select **【Maintenance】** →input maintenance password→Enter.
2. Select **【Module】** submenu→ **【Other】** submenu.
3. Set **【NIBP Invalid Time】** .

12.8.9. Displaying the NIBP List

To display multiple sets of the latest NIBP measurements, follow this procedure:

1. Enter **【Screen Layout】** submenu by either of the following ways:
 - ◆ Select **【Screen Setup】** quick key→Select **【Screen Layout】** submenu.
 - ◆ Select **【Main Menu】** quick key→from **【Display】** column to select **【Screen Layout】** .
2. In the desired parameter area, select **【NIBP】** → **【NIBP List】** .

12.9. Assisting Venous Puncture

You can use the NIBP cuff to cause sub-diastolic pressure to block the venous blood vessel and therefore help venous puncture. To assist venous puncture, follow this

procedure:

1. Select the NIBP parameter area.
2. Select **【Setup】** submenu;
3. Set **【Assisted Venipuncture Pressure】** .
4. Select **【Assisted Venipuncture】** at the bottom of the menu.
5. Puncture vein and draw blood sample.
6. Select **【NIBP Start/Stop】** quick key or **【Assisted Venipuncture】** button to

manually deflate the cuff. When performing a venipuncture, observe the inflation pressure and the remaining time of the venipuncture in the NIBP parameter area.

12.10. NIBP Maintenance

12.10.1. NIBP Leakage Test

The NIBP leakage test checks the integrity of the system and of the valve. The NIBP leakage test should be performed once every two years or when you doubt the NIBP measurements. The NIBP leakage test should be performed by qualified service personnel only.

12.10.2. NIBP Calibration

The NIBP accuracy test should be performed once every two years or when you doubt the NIBP measurements. The NIBP accuracy test should be performed by qualified service personnel only.

12.11. NIBP Troubleshooting

For more information, see *D Alarm Information*.

Chapter 13 IBP

13.1. Introduction

The method of IBP measurement is direct measuring the BP of artery or veins on the pressure sensor mainly through liquid coupling so as to obtain the pressure curve of the continuous BP.

The monitor can provide up to 2 channels of IBP measurement results.

13.2. Safety information



WARNING:

- **Use only IBP transducers specified in this manual. Never reuse disposable pressure transducers.**
 - **The operator should avoid contact with conductive parts of the accessories when being connected or applied.**
 - **When the monitor is used with HF surgical equipment, the transducer and the cables must be avoided conductive connection to the HF equipment to protect against burns to the patient.**
 - **All invasive measurement involves risks to the patient. Use aseptic technique and perform according to manufacturer's instructions during measurement.**
 - **Mechanical shock to the IBP sensor may cause severe shifts in zero balance and calibration, and cause erroneous readings.**
-

13.3. IBP measurement

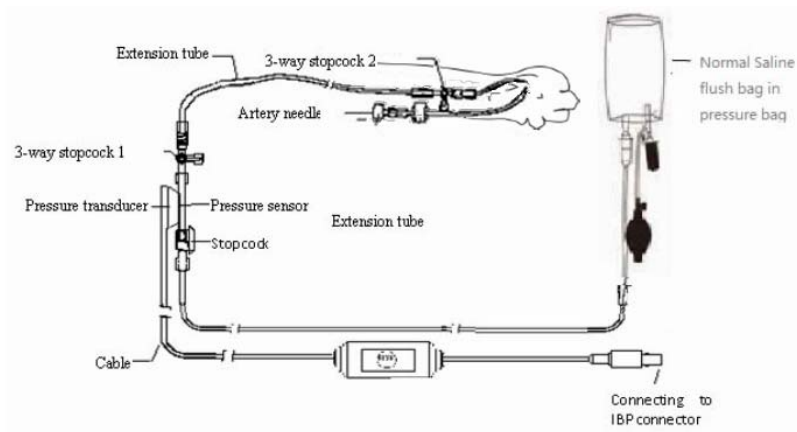

13.3.1. Monitoring Procedure

Please make an IBP measurement following below steps:

1. Plug one end of the IBP sensor cable into the monitor's IBP cable connector and the other end link to the IBP sensor.
2. Refers to the IBP sensor manufacturer's instructions for exhausting air in the IBP sensor, it make ensure no air bubbles in the sensor's entire tube.
3. Connecting IBP sensor to the patient, which makes sure the sensor and heart at the same level.
4. Selecting correct pressure label based on the measured pressure. Specifically, please refer to **13.5.2 Change the pressure label**.
5. Refers to **13.3.2 IBP Sensor Zero** for zeroing. During this process, the sensor keeps stationary and the valve is open to the atmosphere.



CAUTION:

- Before IBP measurements, it should make sure all IBP sensors are zeroed properly.
- Before IBP measurement, it makes sure no air bubbles in the IBP sensor which result in erroneous pressure readings.
- When intracranial pressure (ICP) measurements put on a sitting patient, the

sensor should be in line with the top of the patient's ear. Incorrect position can result in erroneous pressure readings.

13.3.2. IBP sensor Zero

To obtain accurate pressure readings, the monitor requires a valid zero point. Zeroing the sensor at the hospital's specified frequency, and zeroing must be performed in the following cases:

- ◆ Every time reconnecting IBP sensor and IBP sensor cable.
- ◆ The monitor needs restart.
- ◆ Suspecting the monitor's pressure reading is inaccurate.
- ◆ When the monitor displays the message **【Zero Required】**, Please refer to the following steps to calibrating zero:
 1. Connecting IBP sensor, sensor cable and module.
 2. Closing the 3-way stopcock (nearby the sensor end) to the patient's valve, and let the sensor pass through the 3-way stopcock to the atmosphere.
 3. Zeroing the sensor using one way from the following methods:
 - Select the parameter area of the pressure (e.g. ART) and select the **【Zero】** button.
 - Click **【Zero】** quick key→select **【IBP zero】** submenu→select the pressure to zeroing.
 4. After successful zero, close the valve to the atmosphere and open the valve to the patient. During zero process, when pressure fluctuation or the pressure exceeds the zero pressure range, it may fail. If fails, the processing method as follows:
 - Check valve position of the 3-way stopcock near the sensor end for ensure access to the atmosphere.
 - Perform zero against. Do not shake the IBP sensor and tubing during zero calibration.

13.4. IBP Display

IBP measurements display the waveforms of pressure and pressure values on the

screen. For arterial pressure, IBP parameter area displays systolic pressure, diastolic pressure and mean pressure. For venous pressure, the IBP numeric area displays only the mean pressure. The figure below shows the waveform and numerics for the Art pressure.

◆ Waveform display



◆ Parameter Display

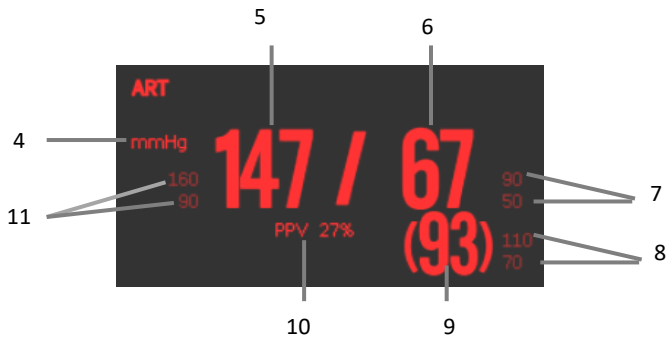

- (1) IBP label
- (2) Waveform scale
- (3) Waveform
- (4) Pressure unit: mmHg, kPa or cmH₂O
- (5) Systolic pressure
- (6) Diastolic pressure
- (7) Diastolic pressure alarm limit
- (8) Mean pressure alarm limit
- (9) Mean pressure
- (10) PPV measurement value
- (11) Systolic pressure alarm limit

13.5. Setting IBP

13.5.1. Setting the IBP alarm

You can set the alarm by following the steps below:

1. Select the IBP parameter area or waveform area to enter the IBP menu.
2. Select **【Alarm】** submenu.

If the alarm setting is protected by password, enter the password. For detail, please refer to *7.6.2 Changing Alarm Setup Protection Mode*.

3. Set alarms as needed.

13.5.2. Change the pressure label

The pressure label is identifier for each type only, so the pressure label must be set up when making pressure measurements. You can choose a pressure label following these steps:

1. Selecting IBP parameter area or waveform area where you need to change labels for enter corresponding IBP menu.
2. Select **【Setup】** submenu.
3. Select **【Label】** where the appropriate tag name in the list.

Label name	Description	Label name	Description
PA	Pulmonary artery pressure	CVP	Central venous pressure
Ao	Aortic pressure	LAP	Left atrial pressure
UAP	Umbilical arterial pressure	RAP	Right atrial pressure
BAP	Brachial arterial pressure	ICP	Intracranial pressure
FAP	Femoral arterial pressure	UVP	Umbilical venous pressure
ART	Arterial blood pressure	LV	Left ventricular pressure
PAWP	Pulmonary wedge pressure	P1 to P2	Non-specific pressure label



NOTE:

- The same label name cannot be used for different channels about IBP

13.5.3. Setting up display types about Extended Pressure

If current pressure label is set to the extended pressure (P1 or P2), you could select the type which displays in the parameter area, following these steps:

1. Select the parameter area or waveform area about the extended pressure for entering the corresponding pressure menu.
2. Select **【Setup】** submenu.
3. Set **【Measurement】** :
 - **All**: Corresponding pressure in the parameter area shows all the pressure: systolic pressure, diastolic pressure and mean pressure.
 - **Mean only**: Corresponding pressure in the parameter area only shows the average pressure.
 - **Auto**: The system will automatically shows the pressure is displayed in the parameter area or only the average pressure according to the measured value of the extended pressure.

13.5.4. Setting the pressure sensitivity

The blood pressure value displayed on the monitor is average calculation about the collected data over a period time. The higher the sensitivity, the faster the monitor responds when the patient's blood pressure value changes, but the measurement accuracy is lower. Inversely, the lower the sensitivity, the slower the response of the monitor when the patient's blood pressure value changes, but the measurement accuracy is higher. When monitoring critically ill patients, setting up a higher sensitivity is useful for timely analysis.

You can set up the sensitivity of the current pressure, following these steps:

1. Select the IBP parameter area or waveform area for enter the corresponding pressure menu.
2. Select **【Setup】** submenu.
3. Set **【Sensitivity】** .

13.5.5. Setting the IBP Waveform

You could set up the IBP waveform, following these steps:

1. Select the IBP parameter area or waveform area to enter the corresponding pressure menu.
2. Select **【Setup】** submenu.
3. Make the following settings for the IBP waveform:
 - Set **【Speed】** .
 - Set **【Scale Type】**: If **【Auto】** is selected, the upper and lower scales of the IBP waveform will be automatically adjusted as the waveform amplitude changes.

13.5.6. Turn on PPV measurement

PPV is the pulse pressure variation. When measuring arterial pressure (excluding PA), you can turn on PPV measurements, following these steps:

1. Select the IBP parameter area or waveform area to enter the corresponding pressure menu.
2. Select **【PPV】** submenu.
3. Set **【PPV Measurement】** to **【ON】** .

When **【PPV Measurement】** is setting to **【ON】**, the source of the PPV can be selected.



WARNING:

- **The monitor will calculate the PPV based on any arterial pressure value between heartbeats. The conditions of PPV measurement, and whether the PPV numerical calculation has clinical significance or not, it is applicable or not. It must be judged by a doctor.**
- **Only a doctor can determine the clinical value of PPV information. According to recent scientific literature, the clinical relevance of PPV information is limited to controlled mechanical ventilation and to sedated patients without arrhythmias.**
- **The calculated PPV value may not be accurate under the following conditions:**
 - a) **Respiration rate is less than 8 rpm**
 - b) **During venting, the tidal volume is less than 8ml/kg**

- c) **The patient has acute right ventricular dysfunction (i.e., pulmonary heart disease)**

13.5.7. Changing the pressure unit:

You can change the unit of pressure by following these steps:

1. Select the IBP parameter area or waveform area to enter the corresponding pressure menu.
2. Select **【Setup】** submenu.
3. Set IBP **【Unit】** if needed.

13.5.8. Overlapping IBP Waveforms

Please following steps below, set up the IBP waveform overlay display:

1. Enter the **【Screen Layout】** page, following method:
 - ◆ Select **【Screen Layout】** quick key → select **【Screen Layout】** submenu.
 - ◆ Select **【Main Menu】** quick key → select **【Screen Layout】** from the **【Display】** column.
2. Select **【IBP Overlap】** in the waveform parameter area and select the IBP waveform to be overlapped on the same line on the left side.
3. Repeat the operation of step 2 at other locations with waveform parameter areas if needed.
4. Select to exit Setup page. The overlapped IBP waveform can be displayed on the main interface.



You can open the **【IBP Overlap】** menu by selecting the IBP waveform area to be overlapped on the main screen. In the **【IBP Overlap】** menu, you can make the following settings:

- ◆ Scale

- Set the **【Left Scale】** for arterial pressure.
- Set the **【Right Scale】** for venous pressure.
- ◆ Set the **【Grid】** of the overlapped waveform area.
- ◆ Set the **【Wave Speed】** of the overlapped display waveform.

13.6. IBP troubleshooting

This section describes problems you may encounter during using. You can refer to the following table for troubleshooting. If the problem persists, please contact maintenance staff.



NOTE: See *D Alarm Information* for physiological alarms and technical alarm information.

Problem	Solution
IBP parameter area and waveform area cannot be found on the interface	<ol style="list-style-type: none"> 1. Check whether the display of IBP parameters is set in the 【Screen Layout】 menu or not. For details, see 3.6.1 Setting Parameters to be protected. 2. Check whether the IBP parameter switch is turned on or not. For details, see 3.6.1 Setting Parameters 3. Check the IBP cable, IBP sensor and module are connected or not. 4. Check the valve position of the 3-way stopcock is correct or not. 5. Confirm that the sensor has been zeroed. For details, see 13.3.2 IBP Sensor zero.
P1/P2 does not display systolic and diastolic pressure measurements	Set the displayed pressure to 【All】 . For details, see 13.5.3 Setting up display types about Extended Pressure .

Problem	Solution
IBP reading is unstable	<ol style="list-style-type: none">1. Verify no air bubbles in the IBP sensor system.2. Check if the sensor is fixed.3. Perform zero against.4. Replace the sensor.
Zero failure	<ol style="list-style-type: none">1. Check if the pipeline of the IBP sensor is open to the atmosphere.2. Perform zero against. Do not shake the IBP sensor and tubing during zeroing. For details, <i>see 13.3.2 IBP Sensor zero.</i>3. If zero still fails, replace the sensor.

Chapter 14 Cardiac output (C.O.)

14.1. Introduction

C.O. (cardiac output) measurements were performed using right atrial thermodilution to measure cardiac output and other hemodynamic parameters. The method is injecting a cold solution into the blood circulation system and measure the blood temperature drop caused by the cold solution at a location downstream. In the C.O. measurement window, the temperature change is shown as a curve. The area under the curve is inversely proportional to the C.O. value, and the monitor calculates the C.O. value based on the curve. Since cardiac output is a continuously varying amount, multiple measurements must be taken to obtain a reliable C.O. average. The monitor can retain 5 results, and user can select the desired measurement to perform the average calculation.

14.2. Safety Information

**WARNING:**

- **C.O. measurements may be inaccurate when electrosurgical is performed.**
 - **All invasive measurements bring about risks for the patient. Sterile techniques should be used in the measurements and follow manufacturer's instructions.**
 - **Please use the accessories specified in this manual. When using, avoid contact with the conductive metal body.**
-

14.3. C.O. Measurement Limitation

Factors which can affect the accuracy of C.O. measurement, as following:

- ◆ Injection temperature
- ◆ Volume of injection
- ◆ Baseline of blood temperature of paralyzed patients
- ◆ Inhalation/exhalation cycle
- ◆ The proximity of the floating catheter to the lungs
- ◆ Floating catheter itself

- ◆ Heart rate and hemodynamic status of paralyzed patients
- ◆ In the C.O. measurement process, any solution is quickly injected intravenously for obtaining an accurate C.O. value. It is recommended that:
 - The temperature of the sputum injection must be at least 10 C° , lower than the temperature of the patient's blood.
 - Inject the solution at the end of the expiration.
 - Inject the solution quickly and smoothly.
 - Each injection is completed in 4 to 5 seconds.

14.4. C.O. Display

C.O. Measurement shows no waveform on the main interface, only the values of C.O., C.I. (cardiac displacement index) and TB (blood temperature) are displayed in the parameter area.

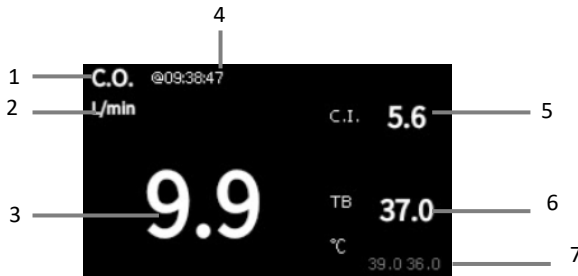

- (1) C.O. label
- (2) C.O. unit
- (3) C.O. measurement value
- (4) Time at which the C.O. average is calculated
- (5) Cardiac index
- (6) Blood temperature
- (7) TB alarm limit

14.5. C.O. Equipment Connecting

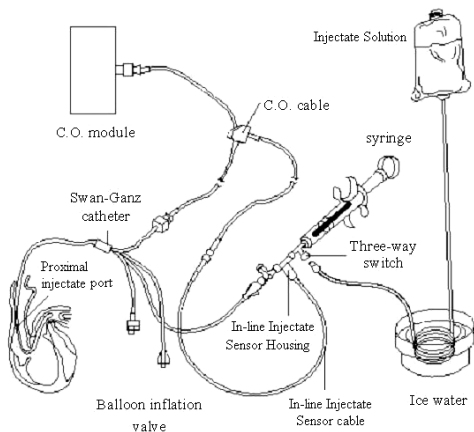

14.6. C.O. Measurement

14.6.1. Preparation of C.O. Measurement

1. Connecting the C.O. cable to the C.O. module or the thermistor interface sensor port, and confirming that the C.O. measurement area is displayed on the monitor.
2. Prepare the C.O. measurement for patients according to regulations and procedures of the hospital department.
3. Connecting the floating catheter and other C.O. measuring accessories in accordance with the manufacturer's manual.
4. Check that the attached accessories are functioning properly.



NOTE: For an out-line probe setup, make sure that the out-line sensor is securely connected to the tubing.

14.6.2. Setting the C.O. Measurement

Before performing C.O. measurement, please following steps for set it up:

1. Selecting C.O. parameters area for enter the **【C.O.】** menu.
2. Select **【Setup】** submenu.
3. Make the following settings:
 - ◆ Set up patient information: Enter the patient's **【Height】** and **【Weight】**, which are used for calculate the C.I. value.
 - ◆ Set **【Catheter Const】**: The C.O. coefficient is a calculation coefficient related to the floating catheter, liquid temperature measurement method (outflow method or ice bath method), injection volume and injection temperature. Please refer to the floating catheter manual. When replacing a floating conduit, its coefficient should be adjusted according to manufacturer's instructions.
 - ◆ Set **【Measure Mode】**. If set **【Continuous】**, the monitor automatically performs measurement when blood temperature is stable. You do not need to select the **【Start】** button on the C.O. measurement interface before C.O. measurement; when setting up **【Single】**, the monitor is on, each measurement is performed after the **【Start】** button is selected.
 - ◆ Set **【TI Source】**. When set **【Auto】**, the system will automatically measure the temperature of the injection. Meanwhile, the **【TI Value】** option is not available; when setting up **【Manual】**, you need to manually enter the temperature of the injection at **【TI Value】**.

14.6.3. Measure C.O.

Following steps for make C.O. measurement:

1. Selecting C.O. parameters area for enter the **【C.O.】** menu.
2. Click the **【C.O. Measuring】** button at the bottom of the C.O. setup menu.

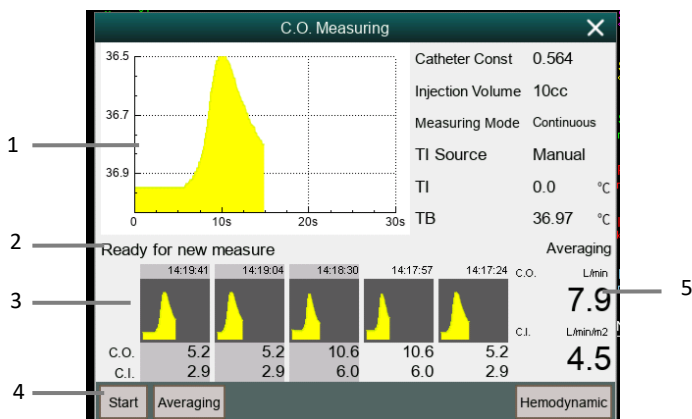

- (1) Current measured C.O. curve
- (2) Prompt information area
- (3) History measurement window
- (4) Function button
- (5) Average of C.O. and C.I. measured multiple times

3. Follow steps for make a C.O. measurement:

- ◆ When **【Measure Mode】** is setting to **【Single】**, when the prompt information area displays **【Ready for new measure】**, you can select the **【Start】** button and immediately perform a rapid liquid injection. The C.O. measurement window will be show the hot dilution curve immediately. After each measurement, its measurement results will be displayed in the historical measurement window. It takes a certain amount of time to repeat this step and start the next measurement.
 - ◆ When the **【Measurement Mode】** setting up **【Continuous】**, the C.O. measurement can be performed continuously. When you see the message **【Injection now】** on the C.O. measurement interface, you can start the measurement by injecting ice water.
4. Obtaining the average value of C.O. and C.I. After completing multiple measurements, select multiple measurement curves if needed in the historical measurement window, and then select the **【Averaging】** button. The system

will calculate and display the average values of C.O. and C.I., and the average will be stored and displayed in parameter area.

At the time of injection, the 3-way stopcock opens to the floating catheter end and closes to the injection end. At the end of the measurement, close the end to the floating catheter, open to the end of the injection, and then inhale the injection into the syringe.

In addition, in the C.O. measurement window, you can also choose:

- **【Stop】** : Press this button during measurement to cancel this measurement.
- **【Setup】** : Enter into the **【Setup】** page of the **【C.O.】** menu. This option is displayed when the **【C.O. Measuring】** hotkey enters the C.O. measurement window.
- **【Hemodynamics】** : Enter the **【Calculate】** menu. *See Chapter 19 Calculation.*



NOTE:

- **Starting a measurement without blood temperature being stable may cause measurement failure.**
- **During the measurement of C.O., the blood temperature alarm is invalid. After the measurement is finished, the blood temperature alarm will automatically resume. Please refer to the instruction manual of the floating catheter to determine the **【Catheter Const】** and the volume of the injection.**

14.7. C.O. Setting

14.7.1. Setting the TB Alarm

You can set up the TB alarm by following these steps:

1. Selecting C.O. parameters area for enter the **【C.O.】** menu.
2. Select the **【Alarm】** submenu.
3. Set the alarm if needed.

14.7.2. Setting the temperature unit

You can change the unit of temperature, following these steps:

1. Selecting C.O. parameters area for enter the **【C.O.】** menu.
2. Select the **【Setup】** submenu.
3. Set the body temperature **【Temp Unit】** .

14.7.3. Setting the C.O. Measurement Value Invalid Time

If the measured value of C.O. is not updated once more within setting time, its measured value is displayed as a hollow number, which indicates the current measured value has expired. You could set up the time when the C.O. measurement value expires, following steps:

1. Select **【Main Menu】** quick key→select **【Maintenance】** from **【System】** column→input password→Enter.
2. Select **【Module】** submenu.
3. Select **【Other】** submenu.
4. Set **【C.O. Invalid Time】** .



NOTE:

- **When the measured value of the non-continuous measurement parameter is displayed as a hollow number, it means that the measurement result has expired. It is not recommended.**
 - **Other settings, such as patient information (height, weight), catheter coefficient, measurement mode, and injection temperature source, see 14.6.2 *Setting the C.O. Measurement.***
-

14.8. C.O. Troubleshooting

This section describes the problems you may encounter during using. You can refer to the following table for troubleshooting. If the problem still persists, please contact maintenance staff.



NOTE: See the *Appendix D Alarm Information* for physiological alarms and technical alarm information.

Problem	Solution
<p>Cannot find out C.O. parameter area on the interface</p>	<ol style="list-style-type: none"> 1. Check if the display of C.O. parameter is set in the 【Screen Layout】 menu. For details, see <i>3.6.2 Setting Display Screen</i>. 2. Check whether the C.O. parameter switch is on or not. For details, see <i>3.6.1 Setting Parameters</i>. 3. Check whether the C.O. cable, floating catheter and liquid temperature sensor are connected or not.
<p>Suspected that the C.O. measurement is inaccurate</p>	<ol style="list-style-type: none"> 1. Check whether the floating catheter position is correct or not. 2. Check out whether the catheter coefficient matches the injection temperature, volume, and temperature measurement methods. 3. Inject the solution quickly and smoothly. 4. Complete each injection in 4 to 5 seconds. 5. Increase the volume of the injection or lower the temperature of the injection. 6. Check the 【Setup】 page, the patient's 【Height】 and 【Weight】 settings are correct. 7. Check 【Setup】 page, when 【TI Source】 is manual, 【TI Value】 is input correctly.
<p>C.O. Measurement failure</p>	<ol style="list-style-type: none"> 1. Increase the volume of the injection or decrease the temperature of the injection. Check that the temperature of the injection must be at least 10°C lower than the temperature of the patient's blood.

Problem	Solution
	<ol style="list-style-type: none"><li data-bbox="393 169 964 193">2. Complete the injection smoothly within 4 to 5 seconds.<li data-bbox="393 213 1005 277">3. Check whether the C.O. cable, floating catheter and liquid temperature sensor are connected or not.

Chapter 15 Carbon Dioxide (CO₂)

15.1. Introduction

The monitor adopts infrared absorption technology to measure the carbon dioxide (CO₂) concentration in the breathing airway of patient. Because CO₂ molecule can absorb infrared light of special wavelength, and the amount of absorbed infrared light directly relates to the concentration of CO₂, therefore while the infrared light radiated from the infrared light source passing through the gas sample containing CO₂, part of energy will be absorbed by CO₂ in the gas. At another side of infrared light source, a photodetector is used to measure the remaining infrared energy and convert it to electric signal, which will be compared with the energy of infrared light source and adjusted so as to correctly reflect the CO₂ concentration in the gas sample.

There are two methods for measuring carbon dioxide in the patient's airway:

1. Mainstream: Uses a CO₂ sensor attached to an airway adapter directly inserted into the patient's breathing system.
2. Sidestream/Microflow: Takes a sample of the respiratory gas with a constant sample flow from the patient's airway and analyzes it with the CO₂ sensor.

15.2. Safety information



WARNING:

- **When placing pipes such as sampling tubes, prevent the pipes from suffocating the patient's throat.**
-



CAUTION:

- **When the patient is being treated with aerosolized drugs, the measured EtCO₂ value may be inaccurate and is not recommended for use in this situation.**
- **The EtCO₂ value measured by the CO₂ module may differ from the CO₂ partial pressure value measured by blood gas analysis.**
- **The CO₂ module has an automatic alarm suppression function, and the CO₂**

module performs a physiological alarm only after the respiratory wave is detected. When monitoring the patient with the CO₂ module, make sure the device is properly connected to the patient.

15.3. CO₂ Measurement Limitations

The following factors may affect the accuracy of the measurement:

- ◆ Leaks or internal venting of sampled gas;
- ◆ Mechanical shock;
- ◆ Cyclical pressure of up to 10kPa (100cmH₂O) and abnormal pressure change of the gas path;
- ◆ Other sources of interference (if any).

Measurement accuracy of the sidestream/microflow CO₂ module may be affected by the breath rate and inspiration/ expiration (I/E) ratio as follows:

- ◆ EtCO₂ value is within specification for breath rate ≤ 60rpm and I/E ratio ≤ 1:1.
- ◆ EtCO₂ value is within specification for breath rate ≤ 30rpm and I/E ratio ≤ 2:1.

15.4. Monitoring Procedure

15.4.1. Mainstream CO₂ Module

1. Attaching the CO₂ sensor cable
Plug the cable of CO₂ sensor into CO₂ connector on the monitor.
2. Selecting a proper airway adapter

Select an airway adapter based on the patient's size, ET tube diameter and monitoring situation. For more information refer to the following table or contact manufacturer.

Airway Adapter Type	ET Tube Diameter
Big animal (Disposable)	>4.0mm
Big animal (Reusable)	>4.0mm
Small animal (Disposable)	≤4.0mm
Small animal (Reusable)	≤4.0mm

3. Attaching the airway adapter to the CO₂ sensor

Before attaching the airway adapter to the CO2 sensor, verify that the airway adapter windows are clean and dry. Clean or replace the adapter if necessary.

Follow these steps:

- 1) Align the arrow on the bottom of the airway adapter with the arrow on the bottom of the sensor.
- 2) Press the sensor and airway adapter together until they click.
- 3) Wait for the airway adapter and sensor to warm up.

The monitor will display the “**Sensor Warm Up...**” message for approximately 1 minute while the sensor and adapter warm to operating temperature. The message disappears when the sensor is ready for use.

Since the Masimo IRMA CO2 mainstream module has a faster heating rate, there is no “**Sensor Warm Up...**” prompt.



CAUTION:

- **The atmospheric pressure must be set to the correct value before using the mainstream CO2 module. Incorrect atmospheric pressure settings can result in erroneous CO2 readings (Masimo IRMA CO2 mainstream modules do not function because they already have automatic atmospheric pressure compensation).**
- **Install the sensor above the adapter to avoid liquid build-up on the adapter window. Gas concentration at high concentrations at this location can hinder gas analysis.**
- **To avoid dead space, place the sensor and adapter as close as possible to the patient.**

-
4. Perform a zero, the details refer to *15.8 Zeroing*.
 5. After the zero is finished, take the Masimo IRMA CO2 module as an example and connect the air circuit as shown below.

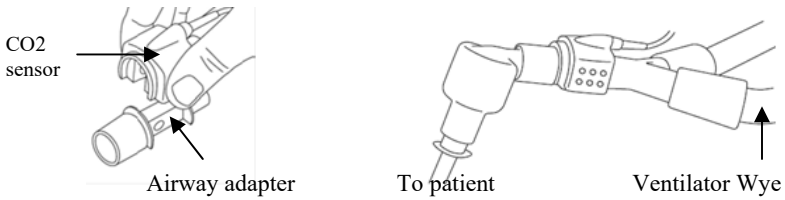

6. Check before use:

- ① Before connecting the airway adapter to the breathing circuit, check if the readings on the monitor are correct.
 - ② Before connecting the airway adapter to the patient circuit, verify the gas reading and waveform through the display on the monitor.
 - ③ After installing the mainstream CO₂ sensor on the airway adapter, please check the tightness of the patient circuit.
- ◆ Status indicated by LED on Masimo IRMA CO₂ sensor:

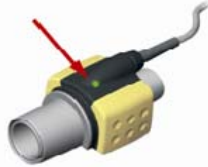

LED	The indicated status
Steady green light	System OK
Blinking green light	Zeroing in progress
Steady red light	Oxygen battery error
Blinking red light	Check adapter

15.4.2. Sidestream/Microflow CO₂ module

1. Attaching the CO₂ sensor cable

Plug the sensor cable into the CO₂ connector on the monitor, and the sensor should be properly placed.

2. Attaching the catheter, airway adapter or sampling tube

Connect the catheter, airway adapter or sampling tube to the sensor as required. Take Nomoline ISA CO₂ module as an example, as shown in the following figure:

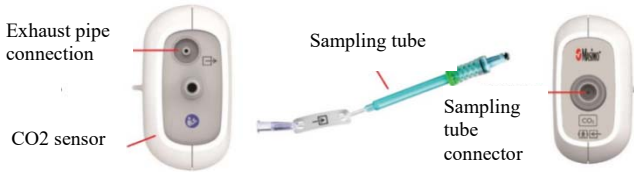

NOTE:

- **Inserting the sampling tube into the sampling tube connector will automatically start the sampling pump. After the sampling tube is pulled out, the sampling pump stops.**
-

3. If the sampling pump fails to turn on, or runs intermittently, perform a “Zero” procedure. (Refer to the *15.8 Zeroing*)
4. Ensure that the CO₂ sensor exhaust tube vents gases away from the sensor environment.
5. Wait for the CO₂ sensor to warm up. The monitor will display the “**Sensor Warm Up...**” message for approximately 1 minute while the sensor warms up to operating temperature. The message disappears when the sensor is ready for use.
6. Applying airway adapter or cannula:
 - 1) For intubated patients requiring an airway adapter: Install the airway adapter at the proximal end of the circuit between the elbow and the ventilator Y section. Shown as follows:

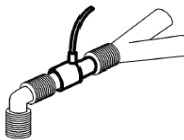

- 2) For intubated patients with an integrated airway adapter in the breathing circuit: Connect the male connector on the straight sample line to the female port on the airway adapter. Shown as follows:

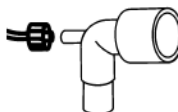

- 3) For non-intubated patients: Place the nasal cannula onto the patient. Shown as follows:



- 4) For nasal or oral-nasal cannulas with oxygen delivery, place the cannula on the patient as shown then attach the oxygen supply tubing to the oxygen delivery system and set the prescribed oxygen flow.



CAUTION:

- Always connect the airway adapter to the sensor before inserting the airway adapter into the breathing circuit. In reverse, always remove the airway adapter from the breathing circuit before removing the sensor.
- Always disconnect the cannula, airway adapter or sampling tube from the CO₂ sensor when not in use.
- Pull the sampling tube out of the sampling tube connector when not in use.
- Do not insert the things other than sampling tube into receptacle of sampling tube.
- The sampling tubes are disposable. Please keep the sampling tube clean, and prevent the tube from clogging by dust. Under the conditions that the sampling gas temperature is 37°C, the indoor temperature is 23°C, and the sampling relative humidity is 100%, replace the sampling tube at least every 12 hours (if filter tip is used, it can be extended to 120 hours), or replace the sampling tube when the sampling tube is found to be leaking, damaged or contaminated.
- When using a microflow CO₂ module, the exhaust holes on the module must be connected to the exhaust gas treatment system.

-
7. Pre-use inspection (pre-use inspection must be performed before connecting the sampling tube to the patient's breathing circuit):
- Insert the sampling tube into the air inlet on the module.

- ② Check whether the LED aperture on the module is green and always bright. (a green light indicates that the system is normal)
- ② Exhale toward the sampling tube and check whether CO₂ waveform and value are displayed on the monitor.
- ② Block the sampling tube with your fingers and wait for 10s.
- ② Check whether the blockage alarm is displayed, and whether the LED aperture on the module flashed red at the same time.
- ② Under appropriate circumstances, check the tightness of the patient's breathing circuit connected with the sampling tube.
- ◆ Status indicated by LED aperture on Nomoline ISA CO₂ module:



LED aperture	The indicated status
Steady green light	System OK
Blinking green light	Zeroing in progress
Steady red light	Sensor error
Blinking red light	Check sampling tube

15.5. Display

◆ Waveform Display



◆ Parameter Display

2



- | | | |
|--------------------------------------|---|---|
| (1) CO ₂ waveform | 5 | (5) EtCO ₂ value |
| (2) Parameter label | | (6) Inspired minimum CO ₂ (FiCO ₂) |
| (3) Unit of CO ₂ | | (7) Airway respiration rate (awRR) |
| (4) Alarm limit of EtCO ₂ | | |

15.6. Settings CO₂

15.6.1. Setting the CO₂ Alarm

1. Select the CO₂ parameter area or waveform area to enter the **【CO₂】** menu.
2. Select **【Alarm】** submenu.
 - If the alarm setting is protected by password, enter the password. For detail, please refer to **7.6.2 Changing Alarm Setup Protection Mode**.
3. Set alarms as needed

15.6.2. Settings Apnea Alarm Time

You can set the apnea alarm time by following the steps below. The monitor will trigger the alarm when the patient's suffocation time exceeds the set time.

1. Select the CO₂ parameter area or waveform area to enter the **【CO₂】** menu.
2. Select **【Alarm】** submenu.
3. Set **【Apnea Delay】** .



WARNING:

- It is cannot judge the cause of respiratory apnea through CO₂ monitoring. If the monitor cannot detect the patient's breath again from the moment of the last breath to the preset time, the monitor only provides the alarm of respiratory apnea. Therefore, the alarm of respiratory apnea should not be used for the diagnosis of the patient.

15.6.3. Changing the CO₂ Unit

To change the CO₂ unit, follow this procedure:

1. Select the CO₂ parameter area or waveform area to enter the **【CO₂】** menu.
2. Select **【Setup】** submenu.
3. Set CO₂ **【Unit】** .

15.6.4. Setting the CO₂ Waveform

To set the CO₂ waveform, follow this procedure:

1. Select the CO₂ parameter area or waveform area to enter the **【CO₂】** menu.
2. Select **【Setup】** submenu.
3. Set CO₂ waveform **【Wave Mode】** , **【Wave Speed】** or **【Scale】** .

15.6.5. Setting CO₂ Corrections

Temperature, water vapor in the patient's breath, barometric pressure, and the proportions of O₂, N₂O and Helium in the mixture all influence CO₂ absorption.

For mainstream and sidestream/microflow CO₂ module, you can set the CO₂ correction by following the steps below:

1. Select the CO₂ parameter area or waveform area to enter the **【CO₂】** menu.
2. Select **【Setup】** submenu.
3. Please set the following contents according to the actual situation before correction:

—— **【Gas Temperature】** : Set the temperature of gas.

—— **【Barometric Pressure】** : Set the atmospheric pressure.

The system default barometric pressure is 760mmHg, you can select **【Main Menu】** quick key→from **【System】** column to select **【Maintenance】** →in **【Other】** submenu to enter the barometric pressure value of the environment.

—— **【Zero Gas Type】** : Select the gas type of zeroing, the options are **【Zero On Room Air】** or **【Zero On N₂】** .

—— **【O₂ Compensation】** : Select the concentration of oxygen. It can be set to a value between 0% and 100%. The default value is 16%.

—— **【Anesthetic Gas】**: Select the concentration of anesthetic agent. It can be set to a value between 0.0% and 20.0%. The default value is 0.0%.

—— **【Balance Gas】**: Select the type of balance gas, the options are **【Room Air】**, **【N₂O】** or **【Helium】** .

When the most proportions of the mixture is air, select **【Room Air】** When the most proportions of the mixture is N₂O, select **【N₂O】** . When the most proportions of the mixture is Helium, select **【Helium】** .

The Masimo mainstream/sidestream CO₂ module supports automatic air pressure compensation and automatic temperature compensation. Manual setting is not required under normal conditions, but other gas interferences may exist in the gas circuit. In order to ensure accurate measurement of Masimo module, the following compensations can be manually set according to actual conditions:

—— **【O₂ Concentration】** : Set the oxygen concentration. Can choose 0% ~ 100%, the default value is 16%.

—— **【N₂O Concentration】**: Set the concentration of N₂O. Can choose 0% ~ 100%, the default value is 0%.



WARNING:

- **Please set the CO₂ corrections according to actual situation, otherwise, the measured value may be inaccurate and away from actual value.**
-

15.6.6. Operating mode

You can select the operating mode of the CO₂ module according to the actual situation of the module. The operation steps are as follows:

1. Select the CO₂ parameter area or waveform area to enter the **【CO₂】** menu.
 2. Select **【Setup】** submenu.
 3. Set **【Operation Mode】** .
- Measure: Select measurement mode is required when measuring with the CO₂ module.

- Sleep: When not using CO₂ for monitoring, it is recommended to set the CO₂ module to sleep mode to increase the life of the CO₂ module.

15.7. Entering Intubation Status

When performing intubation during general anesthesia, you can enter the intubation mode in order to reduce unnecessary alarms. To enter the intubation mode, follow this procedure:

1. Select the CO₂ parameter area or waveform area to enter the **【CO₂】** menu.
2. Select **【Intubation Status】** button.

For the details of the intubation mode, see *7.11 Intubation Status*.

15.8. Zeroing

■ Mainstream and Sidestream / Microflow CO₂ Module

While zeroing is recommended the first time a CO₂ sensor is connected to the monitor, it is only absolutely necessary when the message “**Zero Required**” is displayed.

Follow these steps:

1. Ensure that the catheter or airway adapter is not connected to the patient or close to any source of CO₂ (including the patient's, your own exhaled breath and ventilator exhaust valves).
2. Using any of the following methods to perform zeroing:
 - Select the CO₂ parameter area or waveform area, and then select **【Zero】** button.
 - Select **【Zero】** quick key → Select **【CO₂ Zero】** submenu → select the CO₂ to zero.

The screen prompts **【CO₂ Zero In Progress...】**, and the message disappears after the zeroing is completed.

For Nomoline ISA CO₂, the sampling tube should be pulled out for automatic zero when needed.

**CAUTION:**

- Before zeroing, the BLT sidestream/ microflow CO₂ sensor must be connected with the sampling tube.
 - Before zeroing, the mainstream CO₂ sensor must be connected with the airway adapter.
 - Zeroing should not be performed for 20 seconds after the airway adapter or cannula is separated from the patient's airway. Wait a moment before zero correction to dissipate the remaining CO₂ in the adapter or cannula.
 - Zeroing should not be performed when the airway adapter or cannula is connected to the patient's trachea.
 - When the temperature is not stable, please do not adjust to zero.
 - When CO₂ remains in the airway adapter or casing, zeroing will result in inaccurate measurement or other error conditions. The time required for zeroing will also increase.
 - When zeroing, do not rely on gas readings.
 - Nomoline ISA CO₂ module does not require user to manually zeroing, and the user cannot successfully send the zeroing command to the module. When necessary, the sampling tube should be pulled out for automatic zero.
-

15.9. Calibration

The monitor has already been calibrated before leaving factory. User can directly apply it measuring in normal conditions (except for the following three cases). When the following three conditions occur, please return the CO₂ module to the factory for calibration.

- After the CO₂ module is used for half a year and one year;
- Clinicians doubt the accuracy of readings;
- After the latest calibration, atmospheric pressure or height above sea level varies evidently.

15.10. Exhaust Emission



WARNING:

- **When using the sidestream/microflow CO₂ measurement on patients who are receiving or have recently received anesthetics, connect the outlet to a scavenging system, or to the anesthesia machine/ventilator, to avoid exposing medical staff to anesthetics.**
-

Use an exhaust tube to remove the sample gas to a scavenging system. Attach it to the outlet connector of sensor.

15.11. Announcements



WARNING:

- **Do not position the sensor cables or tubing in any manner that may cause entanglement or strangulation.**
- **Reuse, disassembly, cleaning, disinfecting or sterilizing the single patient use cannula kits and on-airway adapters may compromise functionality and system performance leading to a user or patient hazard. Performance is not guaranteed if an item labeled as single patient use is reused.**
- **Before using, please check whether the airway adapter is damaged. Do not use if damage is found.**
- **If excessive secretions are found on the airway adapter, replace them immediately.**
- **When monitoring CO₂ waveform, if changes or abnormal phenomena are found, please check the airway adapter or sampling tube. If necessary, please replace it immediately.**
- **Note whether the baseline of CO₂ waveform is too high. Sensor or patient problems will cause the baseline to be too high.**
- **Regularly check CO₂ sensor and pipeline for excessive moisture or secretion accumulation.**
- **Do not operate the CO₂ module when it is wet or has exterior condensation.**
- **Do not use microflow CO₂ sensors for patients who cannot tolerate the**

withdrawal of 50 mL/min±10 mL/min from the airway or patients that cannot tolerate the added dead space to the airway.

- Do not connect the exhaust tube of sidestream/microflow CO₂ module to the ventilator circuit.
-



CAUTION:

- Use only accessories provided by manufacturer.
 - Do not sterilize or immerse the CO₂ sensor in liquids.
 - Clean the CO₂ sensor and accessories as directed in this manual.
 - Do not apply excessive tension to the CO₂ sensor cable.
 - When aerosol drugs are present, please keep the airway adapter away from the breathing circuit. The viscous substance of the aerosol drug can pollute the window of the airway adapter, and the airway adapter needs to be cleaned or replaced in advance.
 - For further information on the use of Masimo IRMA CO₂ mainstream module and Nomoline ISA CO₂ module, please refer to the user's manual included with the module.
-



NOTE:

- This product and its accessories are latex free.
- After the life cycles of the CO₂ module and its accessories have been met, disposal should be accomplished following national and local requirements.
- Nitrous oxide, elevated levels of oxygen and helium can influence the CO₂ measurement. Please setup gas compensation according to actual state.
- Barometric pressure compensation is required to meet the stated accuracy of the CO₂ module.
- Do not place the airway adapter between the ET tube and the elbow, as this may allow patient secretions to block the adapter windows.
- Position the airway adapter with its windows in a vertical and not a horizontal position, this helps keep patient secretions from pooling on the windows.

15.12. CO₂ Troubleshooting

This chapter describes the problems that may be encountered during the use of the monitor. You can first refer to the following table to eliminate them. If the problem persists, please contact the maintenance personnel.



CAUTION:

- For the physiological and technical alarm messages, see *D Alarm Message*.

15.12.1. The Sidestream/Microflow CO₂ module Troubleshooting

Problem	Solution
EtCO ₂ measurement value too low	<ol style="list-style-type: none"> 1. Judge whether the CO₂ concentration in the use environment is too high. If the environmental concentration is too high, the measured value is too low. If it is more serious, zero will fail. Please pay attention to the ventilation of the environment at this time. 2. Check the sampling tube and connectors for leakage. 3. Check the patient status.

15.12.2. The Mainstream CO₂ Module Troubleshooting

Problem	Solution
Elevated baseline	<ol style="list-style-type: none"> 1. Check the patient status. 2. Check the sensor.

Chapter 16 Drip Monitor (DM)

16.1. Introduction

DM (Drip Monitor) module uses photoelectric non-contact principle to detect the dropping of medical drops in the infusion tube set, trigger the circuit to work, count the dropping frequency of medicine drops, and thus obtains the drip rate of infusion drops. After the completion of infusion is detected, the infusion pipeline is clamped, the infusion is blocked and a signal is sent to the monitor, and the monitor generates an infusion completion alarm message according to the signal to prompt medical personnel to change the liquid medicine or perform needle pulling operation.



CAUTION:

- **DM only measures the number of drops in the set infusion tube assembly and does not participate in drop control.**
-

16.2. Safety information



WARNING:

- **During measurement, the liquid level in the drip chamber should be kept below the liquid level indicator line of the infusion monitoring module.**
 - **Please make sure that the outside of the drip chamber is not sticky with water, otherwise the dripping rate measurement may be inaccurate.**
 - **The operator should pay attention to the length of the infusion tube and use the extension tube when necessary to avoid accidents caused by pulling infusion tube due to the patients turning over.**
 - **The Drip monitor (DM) measurement function isn't intended to measure the drips rate in the infusion process of analgesic, chemotherapy medicine and insulinum.**
-



CAUTION:

- In order to ensure the accuracy of dripping rate measurement, the drip monitor module should be vertically installed or naturally hung on the infusion stand using matching bracket.
 - This function is an assistive technology implementation method designed for the high-quality infusion nursing services, and cannot replace manual monitoring and speed control operations during infusion.
 - This function is suitable for working under relatively static conditions. Therefore, avoid using it in a moving state, and avoid shaking and tilting at a large angle. When the water mist and small water drops in the dropper are seriously hung on the wall, it may interfere with the detection. If necessary, you can flick the wall of the dropper with your finger to shake off the small water drops.
 - The DM module uses infrared sensing to detect, so it should be avoided in strong light environment.
-

16.3. DM measurement

16.3.1. Start infusion

16.3.1.1. Connect DM module cable

Insert the DM module cable into the DM socket on the monitor, and the drip monitor interface will be displayed on the monitor.

16.3.1.2. Pre-perfusion infusion tube

Close the flow clamp tightly and connect the infusion tube set with the infusion container, then squeeze the drip chamber and pour the liquid medicine to the 1/2 position of the drip chamber. Open the flow clamp, fill the liquid medicine to the tip needle, and then close the flow clamp tightly.

16.3.1.3. Install infusion tube set into DM module

Push the drip chamber into the slot of the drip chamber of the DM module, and clamp the pipeline which is connected to the lower part of the drip chamber into the clamping groove of DM module, as shown in the figure. The DM module is fixed to a suitable position by means of supporting brackets or hanging ropes. Then, exhaust the pipeline to ensure that the gas in the pipe set is exhausted and close the flow clamp tightly.

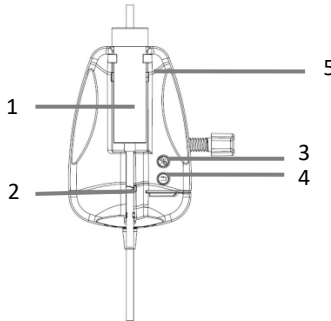

- (1) The slot of the drip chamber
- (2) Liquid stop clamp
- (3) Start/Stop DM button
- (4) Liquid stop clamp reset button
- (5) Liquid level indicator line of DM module



WARNING:

- **Ventilating operation can only be performed when the infusion is not performed and the infusion tube is not connected to the patient.**

16.3.1.4. Configure related parameters

If the unit of mL/h needs to be adopted, can switch “Drops/min” to “mL/h” in the menu of the monitor and set the conversion parameter between the number of drops and mL.



CAUTION:

- **The drip rate corresponding to the 1 mL infusion volume must be entered**

according to the relevant statement of the infusion set used. For example, the Double-Dove tube declares that 20 drops of distilled water are equivalent to 1 mL \pm 0.1 mL, so enter: 20 in the Drops/mL parameter setup.

16.3.1.5. Start DM measurement and adjust drip rate

Connect the infusion tube to the patient, start drip monitor (DM) measurement through the “Start/Stop” button on the DM module, and adjust to the desired drip rate via the flow clamp. The DM module indicator light switches from yellow to green and blinks synchronously with the dropping of liquid drops.

16.3.2. Stop infusion

During the infusion or after the infusion is completed, press the “Start/Stop” button of the DM module, and the indicator light of the module will switch to a yellow state. At this time, the monitor will exit the DM function and will no longer perform drip monitor measurement.



WARNING:

- **In the non-infusion drip monitor state, when infusion is completed, the monitor will not stop the infusion and send out an infusion completion alarm. Just quit DM function, but the infusion is still continuing. If the infusion needs to be stopped, the liquid stop clamp of the tube set needs to be operated to stop the infusion.**
-

16.3.3. Infusion completion

When infusion is completed, the indicator light of DM module is switched to red flashing state, the liquid stop clamp is automatically closed, block the pipeline, stop infusion, and the monitor generates infusion completion alarm.

After recognizing the alarm, the medical staff confirms the alarm, separates the infusion tube from the patient, presses the “Reset” button on the DM module, opens the liquid stop clamp, takes out the infusion tube set, and finishes a drip monitor.

If you need to replace the liquid medicine container, please follow the steps as below:

- 1) When the liquid stop clamp of the DM module is closed, remove the liquid medicine container from the infusion pipeline;
- 2) Connect the infusion pipeline with a new liquid medicine container;
- 3) Open the liquid stop clamp through the “Reset” button on the DM module, and then press the “Start/Stop” button to continue drip monitoring.

16.4. DM module indicator

Status	Indicator
Drip monitoring	The green light is always on and flickers with drops of liquid.
Suspension or stop of infusion	Yellow is always bright.
Infusion completed and stopped	Red light flashing (2Hz)

16.5. DM display

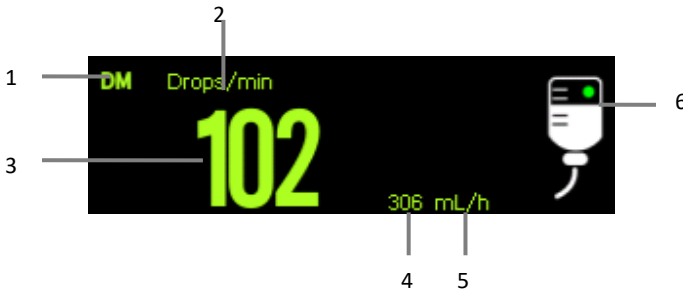

- (1) Parameter Label
- (2) Drip rate unit (main unit)
- (3) The value of drip rate
- (4) The value of flow rate
- (5) Flow rate unit
- (6) Working state diagram

The green dot blinks during drip monitoring, and when when drip monitor is stopped, the yellow dot light without flashing; when the infusion is completed, the whole symbol light white and red alternately.

16.6. Setting DM

16.6.1. Setting main unit

You can set the display of the DM main unit by the following steps as below:

1. Select the DM parameter area to enter **【DM】** menu.
2. Set **【Unit】** of DM. The selected unit is displayed in the DM parameter area in the form of a main unit.

16.6.2. Setting unit conversion parameters

In order to ensure the accuracy of the flow rate, you need to set the conversion parameter between the number of drops and mL. The steps are as below:

1. Select the DM parameter area to enter **【DM】** menu.
2. Set **【Drop Per Milliliter】** of DM. The default value is 20.

16.7. DM check

The DM module has already been verified before leaving factory. Generally, the user can directly measure it. Please contact the manufacturer or maintenance personnel authorized by the hospital to repair the DM module when the following two situations occur:

- The maintenance test is unqualified;
- Clinicians doubt the accuracy of readings.

Chapter 17 Review

17.1. Review Overview

You can know how the patient's condition is developing through reviewing interface to check the trend data, events, waveforms, and so on. You can also view the trend data through the OxyCRG screen to know the changes in the patient's condition.



CAUTION:

- **Changing the date and time will affect the storage of trends and events and may result in data loss.**
-

17.2. Reviewing Page

The review page contains graphic trends and tabular. The review page where each submenu is located displays patient trend data in different forms.

17.2.1. Accessing the Review Page

Choose one of the following methods to enter the review page

- Select **【Review】** quick key.
- Select **【Main Menu】** quick key→from the **【Review】** column select the desired option.

17.2.2. The structure of review page

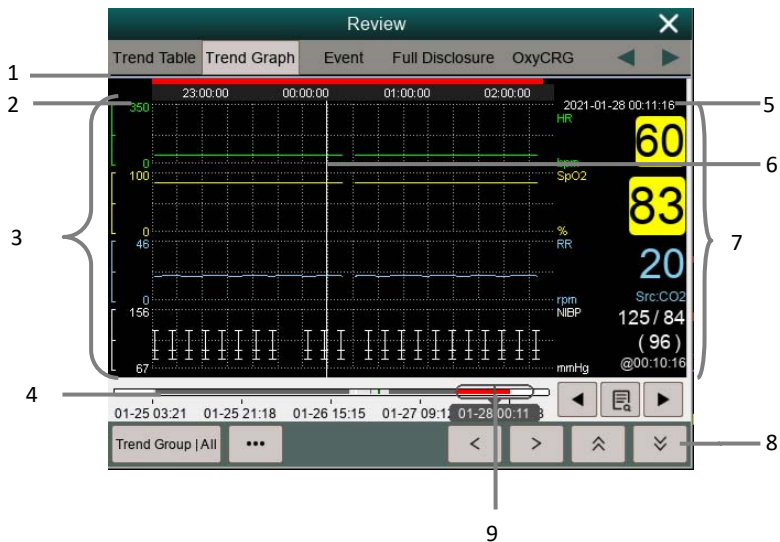

The review pages have similar structure. We take the graphic trends review page as an example. These contents will not be introduced in each review page.



- (1) Event type indicator: Different color blocks match different types of events.
 - Red: high priority alarm event
 - Yellow: medium priority alarm event
 - Cyan: low priority alarm event
- (2) Current window time line: indicates the time length of the current window.
- (3) Waveform area: display trend curves. The color of trend curves is consistent with the color of parameter labels.
- (4) Time line:
 -  can be moved within this time length.
 - Different color blocks at the time line indicate alarm events of different types. The color of the color block is consistent with the color of the event identifier.
- (5) Cursor time
- (6) Cursor
- (7) Waveform area: displays the parameter value at the cursor time.
- (8) Button area
- (9) Slider: indicates the position of current window time in the entire time length. Dragging this button left or right enables you to locate the trend data at a specific time and also refreshes trend data in current window accordingly.

17.2.3. Symbols on Review Pages

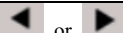
The following table lists the symbols on review pages.

Symbol	Description
	Slider: indicates the position of current window time in the entire time length. Dragging this button left or right enables you to locate the trend data at a specific time and also refreshes trend data in current window accordingly.
 or 	Goes to the previous or next event.
	Event list: displays events in a chronological order. The most recent event is displayed at the top. The number of asterisk symbols (*) before an event an event matches alarm priority.

17.2.4. Common Operations of Review Page

This section describes common operations for all review pages.



17.2.4.1. Browsing Trend Data

In review page, the user can browse trend data in one of the following ways:

- ◆ Move the slider .
- ◆ Move the cursor.
- ◆ Slide page.

17.2.4.2. Viewing events

View the events in one of the following ways:

- ◆ Select  to open the event list. You can select the event you want to view from the event list.
- ◆ Select  or  to view the previous or next events. In event list, events are displayed in a chronological order. The most recent event is displayed at the top. The number of asterisk symbols (*) before an event an event matches alarm priority as follow:
 - ◆ ***: high priority alarm
 - ◆ **: medium priority alarm
 - ◆ *: low priority alarm

17.2.5. Tabular Trends Review Page

The trend table review page displays how the patient's physiological parameter trend is developing in a tabular manner.

17.2.5.1. Entering the Tabular Trends Review Page

Choose one of the following methods to enter the tabular trends review page:

- ◆ Select **【Review】** quick key→Select **【Trend Table】** submenu.
- ◆ Select **【Main Menu】** quick key→from **【Review】** column to select **【Tabular Trends】** .

17.2.5.2. Selecting the Trend Group

The method for selecting trend groups is as follows:

1. Choose one of the following methods to enter the tabular trends review page:
 - ◆ Select **【Review】** quick key→Select **【Tabular Table】** submenu.
 - ◆ Select **【Main Menu】** quick key→from **【Review】** column to select **【Tabular Trends】** .
2. Select **【Trend Group】** button→Select **【Select Trend Group】** submenu.
3. Select the displayed parameter combination as required.

17.2.5.3. Editing the Trend Group

The trend group defines the trend data displayed on the tabular trends review page. If you have selected a **【Trend Group】** other than **【All】** and **【Standard】** , you can edit the trend group. To do so, follow this procedure:

1. Enter the tabular trends review page by either of the following ways:
 - ◆ Select **【Review】** quick key→Select **【Trend Table】** submenu.
 - ◆ Select **【Main Menu】** quick key→from **【Review】** column to select **【Tabular Trends】** .
2. Select **【Trend Group】** button.
3. Select the trend group submenu to edit.
 - ◆ Add parameters: select desired parameters from the **【Choices】** column

on the left and select **【Add】** .

- ◆ Delete parameters: select desired parameter from the **【Selected】** column on the right and then select **【Delete】** .
- ◆ Move the position of parameters: select desired parameters from the **【Selected】** column on the right and select **【Move Up】** , **【Move Down】** , **【Move To Top】** or **【Move To Bottom】** .

Selecting **【Default Config】** will resume the trend group setting to factory defaults.



CAUTION:

- When **【Trend Group】** is set to **【All】** or **【Standard】** , you cannot edit the trend group.
 - ECG parameter and waveform are always displayed in the first row on the trend page. It cannot be deleted or moved.
-

17.2.5.4. Changing the Resolution of Trend Data

The resolution of tabular trends defines the interval of displaying trend data. High resolution is especially suited for the fast-changing clinical situation. If the patient's status changes more gradually, a low resolution will be more informative.

To change resolution, follow this procedure:

1. Enter the tabular trends review page.
2. Select **【...】** to enter setup menu.
3. Select **【Sample Rate】** .
 - **【5s or 30s】** : The trend of parameters in the last 6 hours was observed at intervals of 5 seconds or 30 seconds.
 - **【1 min、5 min、10min、15min、30min、1h、2h、3 h】** : According to the selected time interval, observe the parameter trend of the last 180 hours.
 - **【NIBP】** : The tabular trends show the values of each parameter at the measurement time of NIBP parameters.

- **【C.O.】** : The tabular trends show the values of each parameter at the measurement time of C.O. parameters.

17.2.6. Graphics Trends Review Page

The graphic trends review page displays trend data in a graphic form.

17.2.6.1. Entering the Graphic Trends Review Page

Choose one of the following methods to enter the graphic trends review page:

- ◆ Select **【Review】** quick key→Select **【Trend Graph】** submenu.
- ◆ Select **【Main Menu】** quick key→from **【Review】** column to select **【Graphic Trends】** .

17.2.6.2. Selecting the Trend Group

For more information, see *17.2.5.2 Selecting the Trend Group*.

17.2.6.3. Editing the Trend Group

For more information, see *17.2.5.3 Editing the Trend Group*.

17.2.6.4. Changing the Window Time

To set the length of time for each screen to display data as follows:

1. Enter the graphic trends review page.
2. Select **【...】** to enter setup menu.
3. Select **【Window Time】** .
 - ◆ **【8min、30min】** : Each screen displays trend data for the set time, and you can observe the trend in the last 6 hours.
 - ◆ **【1h、2h、4h】**: Each screen displays trend data for the set time, and you can observe the trend in the last 180 hours.

17.2.6.5. Setting the Number of Waveforms

Follow these steps to select the number of waveforms to display in the graphic trends:

1. Enter the graphic trends review page.
2. Select **【...】** to enter setup menu.
3. Select **【Wave Number】** .

17.2.7. Events Review Page

The monitor stores alarm events and system events in real time. Alarm event types include physiological alarm event. When an alarm event occurs, the monitor will store the values of relevant parameters at the time of occurrence and the relevant waveforms for 16 seconds before and after the time of occurrence.



CAUTION:

- **A sudden loss of power has no impact on the events stored.**
-

17.2.7.1. Entering the Events Review Page

Choose one of the following methods to enter the events review page:

- ◆ Select **【Review】** quick key→Select **【Event】** submenu.
- ◆ Select **【Main Menu】** quick key→from **【Review】** column to select **【Event】** .

The event review page displays a list of events in the order in which they occurred. The most recent event is displayed at the top. The number of asterisk symbols (*) before an event matches alarm priority.

The event identifier on the left side of the alarm event displays different types of events with different color blocks:

- ◆ Red: high priority alarm event
- ◆ Yellow: medium priority alarm event
- ◆ Cyan: low priority alarm event

The number of currently events and the total number of filtered events are displayed

at the top right corner of the event list. For example, 3/10 indicates that there are a total of 10 selected events, and currently there are 3 events.

17.2.7.2. Configuring the Filter

You can filter events by time, alarm priority, parameter category or event type. To configure the filter, follow this procedure:

1. Enter events review page to switch on **【Filter】** .
2. Select **【Filter Setup】** and set the desired filter criterion. Events after filtering will be displayed in the event list.



CAUTION:

- If **【Filter】** is not switch on, the relevant setting in **【Filter Setup】** will not take effect.
-

17.2.7.3. Viewing Event Details

To view waveforms and parameter values at the selected event time, follow this procedure:

1. Enter the event review page.
2. Select **【Detail】** .



CAUTION:

- Please ensure that the best ECG lead with largest waveform amplitude and the highest signal-to-noise ration is selected. Choosing the best ECG lead is very important to recognize cardiac beat, classify cardiac beat and recognize ventricular fibrillation.
-

17.2.8. Full Disclosure Review Page

On the Full Disclosure review page, you can review waveform data up to 72 hours. You can view compressed waveforms, full waveforms and numeric values.

17.2.8.1. Entering the Full Disclosure Review Page

Choose one of the following methods to enter the Full Disclosure review page:

- ◆ Select **【Review】** quick key→Select **【Full Disclosure】** submenu.
- ◆ Select **【Main Menu】** quick key→form **【Review】** column select **【Full Disclosure】** .

17.2.8.2. Selecting Compressed waveforms

To review compressed waveforms, you must first select which parameters to store and display. Follow these steps:

1. Enter the Full Disclosure review page.
2. Select **【Setup】** submenu to enter **【Full Disclosure Setup】** page.
3. Select **【Storage】** submenu and select the desired waveforms to be stored.
4. Select **【Display (Maximum: 3)】** submenu and select the desired waveform to be displayed from the stored waveforms.



CAUTION:

- **If more waveforms are selected in the **【Storage】** column, the storage time of these waveforms will be shortened due to the limitation of memory size. The waveforms may not be stored for 72 hours. Please exert caution when selecting waveforms.**

When an alarm occurs, the band on the compressed waveform at the alarm time will use different shading to indicate different alarm levels.

- ◆ Red: high priority alarm
- ◆ Yellow: med priority alarm
- ◆ Cyan: low alarm priority

17.2.8.3. Setting Gain and Duration

To set the length of time each compressed waveform is displayed and the ECG

waveform height. Follow these steps:

1. Enter the holographic waveform review page.
2. Select **【...】** to enter setup menu.
3. Select **【Duration】** to set the length of time for each compressed waveform display.
4. Select **【Gain】** to set ECG waveform gain.

17.2.8.4. Viewing Details of Compressed Waveforms

To view the full waveforms and numeric values of compressed waveforms, follow this procedure:

1. Enter the holographic waveform review page.
2. Select **【Details】**. You can perform the following operations on this page:
 - ◆ Select **【...】** to set **【Waveform Speed】**, **【Record】** and **【Gain】**.
 - ◆ Select **【Overview】** to return to the compressed waveform page.

17.2.9. OxyCRG Review Page

You can review up to 48 hours' trend curves and compressed waveforms on the OxyCRG review page.

17.2.9.1. Entering the OxyCRG Review Page

Choose one of the following methods to enter the OxyCRG Review Page:

- ◆ Select **【Review】** button on the OxyCRG Review Page.
- ◆ Select **【Review】** quick key→Select **【OxyCRG】** submenu.
- ◆ Select **【Main Menu】** quick key→enter **【Review】** column →Select **【OxyCRG】**.

17.2.9.2. Changing the Resolution of Trend Curves

To set the resolution of trend curves, follow this procedure:

1. Enter the OxyCRG review page.

2. Set **【Zoom】** .

17.2.9.3. Setting the Compressed waveform

To set the compressed waveform, follow this procedure:

1. Enter the OxyCRG review page.
2. Set **【Waveform】** .

Chapter 18 Calculations

18.1. Introduction

The monitor provides calculation functions. The calculated values, which are not directly measured, are computed based on the data and measurement values you enter. The calculation is independent of other monitoring functions and the object of calculation may not be the patient monitored by this monitor. The calculation operation will not affect the patients being monitored.

The following calculations can be performed on this monitor:

- ◆ Drug calculation
- ◆ Hemodynamic calculation
- ◆ Oxygenation calculation
- ◆ Ventilation calculation
- ◆ Nephridium Calculation

18.2. Safety information



WARNING:

- **The dosage of drugs must be decided by the physician in charge.**
 - **During calculation, check that the entered values are correct and the calculated values are appropriate. We assume no responsibility for any consequences caused by wrong entries and improper operations.**
-

18.3. Drug Calculation

The monitor provides the drug calculation function.

18.3.1. Calculation Step

The Drug calculation steps are as follows:

1. Access drug calculation page by either of the following ways:

- ◆ Select **【Calculations】** quick key.
 - ◆ Select **【Main Menu】** quick key→from **【Calculations】** column to select **【Drug】** .
2. Set **【Drug Name】** and **【Patient Type】**. If the selected drug is affected by weight, switch on **【Weight Participation】** and enter the patient's weight.
 3. Enter the drug-related information such as total amount, volume and dose of drugs.
 4. Select **【Calculate】** button to calculate. Red arrow marks are displayed before the calculation results.



CAUTION:

- **If available, the patient category and weight from the patient demographics menu are automatically entered when you first access drug calculation. You can change the patient category and weight. This will not change the patient category and weight stored in the patient demographic information.**
-

18.3.2. Checking the Titration Table

The Titration Table shows informations on the currently used drugs. You can check the dose received by the patient at different infusion rate through the Titration Table. The procedure for viewing the titration table is as follows:

1. Access drug calculation page by either of the following ways:
 - ◆ Select **【Calculations】** quick key.
 - ◆ Select **【Main Menu】** quick key→from **【Calculations】** column to select **【Drug】** .
2. Select **【Titration】** sub menu.
3. Select **【Dose Type】** at the bottom of the interface to set the unit type of drug dose in the titration table.
4. Select **【Step】** to set the interval between two adjacent titration table item.

You can choose the sorting method of titration table:

- ◆ **【Dose】** : The titration table is listed in the sequence of increased drug

dose.

- ◆ **【INF Rate】** : The titration table is listed in the sequence of increased infusion rate.

18.3.3. Drug calculation Formula

Description	Unit	Formula
Dose Amount	g series: mcg, mg, g; unit series: unit, kU, MU; mEq series: mEq;	Dose Amount = Liquid Volume ×drug concentration
Liquid Volume	ml	Manual input required
Drug concentration	mcg/ml, mg/ml, g/ml, Unit/ml, KU/ml, MU/ml, mEq/ml	Drug concentration = Dose Amount / Liquid Volume
Drop Size	GTT/ml	Manual input required
Dose/hr	g series: mcg, mg, g; unit series: unit, kU, MU; mEq series: mEq;	Dose/h=Dose/min × 60
Dose/min	g series: mcg, mg, g; unit series: unit, kU, MU; mEq series: mEq;	DoseMin=DoseMin
Dose/kg/hr (weight based)	g series: mcg, mg, g; unit series: unit, kU, MU; mEq series: mEq;	Dose/h= Dose/h/weight
Dose/kg/min (weight based)	g series: mcg, mg, g; unit series: unit, kU, MU; mEq series: mEq;	Dose/min= Dose/min /weight
INF rate	ml/h	Infusion rate = Dose/h/drug concentration

Description	Unit	Formula
Drip rate	GTT/min	Drip rate = infusion rate*volume per drop/60
Duration	h	Duration = drug amount/dose/h

18.4. Hemodynamic Calculations

The monitor provides the hemodynamic calculation function. The monitor can save the results of up to 20 calculations, which are displayed in groups.

18.4.1. Calculation Step

To perform hemodynamic calculation, follow this procedure:

1. Access hemodynamic calculation page by either of the following ways:
 - ◆ Select **【Calculations】** quick key→ **【Hemodynamics】** submenu.
 - ◆ Select **【Main Menu】** quick key→from **【Calculations】** column to select **【Hemodynamics】** .
2. Enter the correct value for each parameter. For a patient who is being monitored, the currently measured values are automatically taken, and the height and weight are derived from the patient information entered.
3. Select **【Calculate】** to calculate the value of each output parameter. The calculated value is greater than the normal upper limit is indicated by an up arrow “↑”; the calculated value is lower than the normal lower limit is indicated by a down arrow “↓”.
 - ◆ Select **【Range】** to show the normal range of each parameter.
 - ◆ Select **【Unit】** to show the unit of each parameter.

18.4.2. Input Parameters

Abbreviation	Unit	Full Name
C.O.	L/min	cardiac output
HR	bpm	heart rate
PAWP	mmHg	pulmonary artery wedge pressure
MAP	mmHg	artery mean pressure
MPAP	mmHg	mean pulmonary artery pressure
CVP	mmHg	central venous pressure
EDV	mL	end-diastolic volume
Height	cm; inch	height
Weight	kg; lb	weight

18.4.3. Output Parameters and calculation formula

Output Parameter	Unit	Full Name	Formula
C.I.	mL/min/m ²	cardiac index	$C.I. = C.O. / BSA$
BSA	m ²	body surface area	$BSA = HT^{0.725} \times WT^{0.425} \times 0.007184$
SV	mL	stroke volume	$SV = 1000 \times C.O. / HR$
SVI	mL/m ²	stroke index	$SVI = SV / BSA$
SVR	dyn*s/cm ⁵	systemic vascular resistance	$SVR = 79.96 \times \frac{MAP - CVP}{C.O.}$
SVRI	dyn*s*m ² /c m ⁵	systemic vascular resistance index	$SVRI = SVI / BSA$
PVR	dyn*s /cm ⁵	pulmonary vascular	$PVR = 79.96 \times \frac{MPAP - PAWP}{C.O.}$

Output Parameter	Unit	Full Name	Formula
		resistance	
PVRI	$\text{dyn}\cdot\text{s}\cdot\text{m}^2/\text{c}$ m^5	pulmonary vascular resistance index	$\text{PVRI} = \text{PVR} \times \text{BSA}$
LCW	$\text{kg}\cdot\text{m}$	left cardiac work	$\text{LCW} = 0.0136 \times \text{APMAP} \times \text{C.O.}$
LCWI	$\text{kg}\cdot\text{m}/\text{m}^2$	left cardiac work index	$\text{LCWI} = \text{RCW} \times \text{BSA}$
LVSW	$\text{g}\cdot\text{m}$	left ventricular stroke work	$\text{LVSW} = 0.0136 \times \text{MAP} \times \text{SV}$
LVSWI	$\text{g}\cdot\text{m}/\text{m}^2$	left ventricular stroke work index	$\text{LVSWI} = \text{LVSW} / \text{BSA}$
RCW	$\text{kg}\cdot\text{m}$	right cardiac work	$\text{RCW} = 0.0136 \times \text{PMAP} \times \text{C.O.}$
RCWI	$\text{kg}\cdot\text{m}/\text{m}^2$	right cardiac work index	$\text{RCWI} = \text{RCW} / \text{BSA}$
RVSW	$\text{g}\cdot\text{m}$	right ventricular stroke work	$\text{RVSW} = 0.0136 \times \text{MPAP} \times \text{SV}$
RVSWI	$\text{g}\cdot\text{m}/\text{m}^2$	right ventricular stroke work index	$\text{RVSWI} = \text{RVSW} / \text{BSA}$
EF	%	ejection fraction	$\text{EF} = 100 \times \text{SV} / \text{EDV}$

18.5. Oxygenation Calculation

The monitor provides the oxygenation calculation function. The monitor can save the results of up to 20 calculations, which are displayed in groups:

18.5.1. Calculation Step

The oxygenation calculation steps are as follows:

1. Access oxygenation calculation page by either of the following ways:
 - ◆ Select **【Calculations】** quick key→**【Oxygenation】** submenu.
 - ◆ Select **【Main Menu】** quick key→from **【Calculations】** column to select **【Oxygenation】** .
2. Enter the correct value for each parameter. For a patient who is being monitored, the currently measured values are automatically taken, and the height and weight are derived from the patient information entered.
3. Select **【Calculate】** to calculate the value of each output parameter. The calculated value is greater than the normal upper limit is indicated by an up arrow “↑”; the calculated value is lower than the normal lower limit is indicated by a down arrow “↓”.

In the Oxygenation page, you can also perform the following operations:

- ◆ Select **【Oxygen Unit】** , **【Hb Unit】** and **【Pressure Unit】** , then corresponding parameter values will be automatically converted and updated accordingly.
- ◆ Select **【Range】** to show the normal range of each parameter.
- ◆ Select **【Unit】** to show the unit of each parameter.

18.5.2. Input Parameters

Input Parameter	Unit	Full Name
C.O.	L/min	cardiac output
FiO ₂	%	percentage fraction of inspired oxygen
PaO ₂	mmHg, kPa	partial pressure of oxygen in the arteries
PaCO ₂	mmHg, kPa	partial pressure of carbon dioxide in the arteries
SaO ₂	%	arterial oxygen saturation
PvO ₂	mmHg, kPa	partial pressure of oxygen in venous blood
SvO ₂	%	venous oxygen saturation

Input Parameter	Unit	Full Name
Hb	g/L, g/dL, mmol/L	hemoglobin
CaO ₂	mL/dL, mL/L	arterial oxygen content
CvO ₂	mL/dL, mL/L	venous oxygen content
VO ₂	mL/min	oxygen consumption
RQ		Respiratory quotient
ATMP	mmHg, kPa	atmospheric pressure
Height	cm, inch	height
Weight	kg, lb	weight

18.5.3. Output Parameters and calculation formula

Output Parameters	Unit	Full Name	Formula
BSA	m ²	body surface area	$BSA = HT^{0.725} \times WT^{0.425} \times 0.007184$
C(a-v)O ₂	mL/L, mL/dL	arteriovenous oxygen content difference	$C(a-v)O_2 = CaO_2 - CvO_2$
O ₂ ER	%	oxygen extraction ratio	$O_2ER = (CaO_2 - CvO_2) / CaO_2$
DO ₂	mL/min	oxygen transport	$DO_2 = C.O. \times CaO_2$
PAO ₂	mmHg, kPa	partial pressure of oxygen in the alveolar	$PAO_2 = [FiO_2 \times (ATMP - \text{water pressure})] - (PaCO_2 \times 1.25)$ Wherein the water pressure is selected to be 47mmHg (6.3kPa)

Output Parameters	Unit	Full Name	Formula
AaDO ₂	mmHg, kPa	alveolar-arterial oxygen difference	$AaDO_2 = PAO_2 - PaO_2$
CcO ₂	mL/L, mL/dL	capillary oxygen content	$CcO_2 = Hb \times 1.34$ $+ 0.031 \times PAO_2$
Qs/Qt	%	venousad mixture	$Qs/Qt = (CcO_2 - CaO_2) / (CcO_2 - CvO_2)$

18.6. Ventilation Calculations

The monitor provides the ventilation calculation function. The monitor can save the results of up to 20 calculations, which are displayed in groups.

18.6.1. Calculation Step

The ventilation calculation steps are as follows:

1. Access ventilation calculation page by either of the following ways:
 - ◆ Select **【Calculations】** quick key → **【Ventilation】** submenu.
 - ◆ Select **【Main Menu】** quick key → from **【Calculations】** column to select **【Ventilation】**.
2. Enter the correct value for each parameter. For a patient who is being monitored, the currently measured values are automatically taken.
3. Select **【Calculate】** to calculate the value of each output parameter. The calculated value is greater than the normal upper limit is indicated by an up arrow “↑”; the calculated value is lower than the normal lower limit is indicated by a down arrow “↓”.

On the ventilation page, you can also perform the following operations:

- ◆ Select **【Pressure Unit】**, then corresponding parameter values will be automatically converted and updated accordingly.
- ◆ Select **【Range】** to show the normal range of each parameter.
- ◆ Select **【Unit】** to show the unit of each parameter.

18.6.2. Input Parameter

Input Parameter	Unit	Full Name
FiO2	%	percentage fraction of inspired oxygen
RR	rpm	respiration rate
PeCO2	mmHg, kPa	partial pressure of mixed expiratory CO2
PaCO2	mmHg, kPa	partial pressure of carbon dioxide in the arteries
PaO2	mmHg, kPa	partial pressure of oxygen in the arteries
TV	mL	tidal volume
RQ		respiratory quotient
ATMP	mmHg, kPa	atmospheric pressure

18.6.3. Output Parameter and calculation formula

Output Parameter	Unit	Full Name	Formula
PAO2	mmHg, kPa	partial pressure of oxygen in the alveolar	$PAO_2 = [FiO_2 \times (ATMP - \text{water pressure})] - (PaCO_2 \times 1.25)$ Wherein the water pressure is selected to be 47mmHg (6.3kPa)
AaDO2	mmHg, kPa	alveolar-arterial oxygen difference	$AaDO_2 = PAO_2 - PaO_2$
Pa/FiO2	mmHg, kPa	oxygenation ratio	$Pa/FiO_2 = PaO_2 / FiO_2$
a/AO2	%	arterial to alveolar oxygen ratio	$a/AO_2 = (100 \times PaO_2) / PAO_2$
MV	L/min	minute volume	$MV = (TV/1000) \times RR$

Output Parameter	Unit	Full Name	Formula
Vd	mL	volume of physiological dead space	$Vd = \frac{(PaCO_2 - PeCO_2) \times TV}{PaCO_2}$
Vd/Vt	%	physiologic dead space in percent of tidal volume	$Vd/Vt = \frac{(PaCO_2 - PeCO_2)}{PaCO_2} \times 100\%$
VA	L/min	alveolar volume	$VA = (TV - Vd) \times RR$

18.7. Nephridium Calculation

The monitor provides the nephridium calculation function. The monitor can save the results of up to 20 calculations, which are displayed in groups.

18.7.1. Calculation Step

- Access nephridium calculation page by either of the following ways:
 - ◆ Select **【Calculations】** quick key → **【Nephridium】** submenu.
 - ◆ Select **【Main Menu】** quick key → from **【Calculations】** column to select **【Nephridium】**.
- Enter the correct value for each parameter. For a patient who is being monitored, the currently measured values are automatically taken, and the height and weight are derived from the patient information entered.
- Select **【Calculate】** to calculate the value of each output parameter. The calculated value is greater than the normal upper limit is indicated by an up arrow “↑”; the calculated value is lower than the normal lower limit is indicated by a down arrow “↓”.
 - ◆ Select **【Range】** to show the normal range of each parameter.
 - ◆ Select **【Unit】** to show the unit of each parameter.

18.7.2. Input Parameter

Input Parameters	Unit	Full Name
URK	mmol/L	urine pstassium
URNa	mmol/L	urinary sodium
Urine	mL/24h	urine
Posm	mOsm/kgH ₂ O	plasm osmolality
Uosm	mOsm/kgH ₂ O	urineosmolality
SerNa	mmol/L	serumsodium
Cr	umol/L	creatinine
UCr	umol/L	urinecreatinine
BUN	mmol/L	blood urea nitrogen
Height	cm, inch	height
Weight	kg, lb	weight

18.7.3. Output Parameter and calculation formula

Output Parameter	Unit	Full Name	Formula
URNaEx	mmol/24h	urinesodium excretion	$URNaEx = \text{Urine} \times URNa / 1000$
Cosm	mL/min	osmolar clearance	$Cosm = Uosm \times (\text{Urine} / 24 / 60) / Posm$
URKEx	mmol/24h	urine potassium excretion	$URKEx = \text{Urine} \times URK / 1000$

Output Parameter	Unit	Full Name	Formula
CH2O	mL/h	free water clearance	$CH2O = \text{Urine}/24 \times (1 - \text{Uosm}/\text{Posm})$
Na/K	%	sodium potassium ratio	$\text{Na}/\text{K} = \text{URNaEx}/\text{URKEx}$
U/Posm		urine to plasma osmolality ratio	$\text{U}/\text{Posm} = \text{Uosm}/\text{Posm}$
BUN/Cr		blood ureanitrogen creatinine ratio	BUN/Cr
CNa	mL/24h	clearance of sodium	$\text{CNa}(\text{mL}/24\text{hrs}) = \text{URNa} \times \text{Urine}/\text{SerNa}$
Clcr	mL/min	creatinine clearance rate	$\text{Clcr} = \text{Ucr} \times \text{Urine} / \text{Cr} / (\text{BSA} / 1.73) / 1440$
U/Cr		urine-serum creatinine ratio	Ucr/Cr
FENa	%	fractional excretion of sodium	$\text{FENa}\% = (\text{URNa} \times \text{Cr}) / (\text{SerNa} \times \text{Ucr}) \times 100\%$

*: BUN/Cr is a ratio at mol unit system.

Chapter 19 Recording

19.1. Recorder

This monitor uses the thermal recorder which supports various record types. It can output the patient information, measurement data, review data and three waveforms at best.

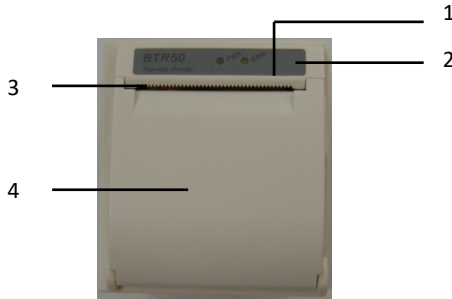

(1) Power indicator lamp

- ◆ ON: The recorder works correctly.
- ◆ OFF: The monitor is switched off.

(2) Trouble indicator lamp

- ◆ ON: There is something wrong with recorder, such as short of paper, door or the recorder not fasten up and something like that.
- ◆ OFF: The recorder goes well.

(3) Paper outlet

(4) Recorder door

19.2. Recording Type

The records can be divided into the following types according to trigger modes:

1. Real-time record of manual startup;
2. The circular record of automatic startup of the recording meter in line with the given time interval.
3. The alarm record triggered by out-of-limit parameter and so on.
4. Record started by manual operation and related to special function.

19.3. Starting Recordings

You can start recording by manual way through the following means:

- Press **【Real-time Record】** quick key below the monitor interface to start real-time recording.
- Select **【Record】** button in the current window or above the menu to start the associated record of the special function.

The recorder can start recording automatically in the following situation:

- If the periodic recording has been started, the recorder will start recording in the set time interval. Refer to *19.6 Setting the Recorder* for detailed instructions.
- When the **【Alm Switch】** and **【Alm Output】** of a parameter are both set to **【On】**, once the parameter gives an alarm, the monitor will be triggered to start an alarm record.

19.4. Stopping Recordings

You can stop recording by manual way through the following means:

- In the process of real-time recording, click the **【Real-time Record】** quick key.

The recorder will stop automatically in the following situation:

- The recorder has finished its task.
- The recorder is sort of paper.
- There is something wrong with the recorder

19.5. Recording Flags

When the printing of the record report is finished, there are the following flags:

- For automatically stopped recordings: Print “***END***” at the end of the report.
- For manually or abnormally stopped recordings: There is no flag printing at the end of the report.

19.6. Setting the Recorder

This section describes the definition of the main setting items. Users can refer to these definitions to select other similar setting items in the device according to their needs.

Select **【Main Menu】** → from **【Report】** column select **【Record Setup】** to enter according corresponding menu.

19.6.1. Selecting the recorded waveform

The recorder can output up to 3 waveforms at a time. In the **【Record Setup】** menu, you can select **【Waveform 1】**, **【Waveform 2】**, **【Waveform 3】** in turn, and then select the name of the waveform in the pop-up list. Select **【Close】** to turn off the output of 1 waveform. These settings apply to real-time recording and periodic recording.

19.6.2. Setting the duration of real-time recording

When starting a real-time recording, the length of recording depends on your setting of recording duration.

1. Open the **【Record Setup】** menu.
2. Set **【Record Duration】** to:
 - ◆ **【8s】** : Record the waveform of 4 seconds before and after the current time.
 - ◆ **【Continue】** : Record the waveform 5 seconds before and after the current time until you manually stop recording.

19.6.3. Setting the interval for periodic recording

You can set a certain time interval, and the recorder automatically starts recording according to the set time interval.

1. Open the **【Record Setup】** menu.
2. Set **【Cycle Record Interval】** .
3. After the setting is completed, the recorder starts each recording at the set interval.

19.6.4. Setting the duration of period recording

You can set the duration of every period recording in the following ways:

1. Open the **【Record Setup】** menu.
2. Set **【Cycle Record Duration】** to:
 - ◆ **【8s】** : Record the waveform of 4 seconds before and after the current time.

19.6.5. Setting the recording speed

1. Open the **【Record Setup】** menu.
2. Set **【Record Speed】** .

This setting is applicable to all recording tasks with waveforms.

19.6.6. Setting alarm recording duration

You can set how long the waveform needs to be recorded when an alarm occurs, as follows:

1. Open the **【Record Setup】** menu.
2. Set **【Alarm Record Duration】** .
 - ◆ **【8s】** : Record the waveform of 4 seconds before and after the alarm triggering time.

19.6.7. Setting NIBP Trigger Record

You can set to record the output NIBP measurement results when NIBP measurement is completed, as follows:

1. Open the **【Record Setup】** menu.
2. Set **【NIBP Trigger】** to **ON** or **OFF**.

19.7. Installing Recording Paper

If the record paper runs out, please install the record paper as the following step:

1. Press both sides of the recorder door with one hand and pull outwards to open

the recorder door;

2. Put the recording paper into the recorder with the thermal side which is smoother up.
3. Close the door of the recorder, and pull some recording paper outside of the paper out port.
4. Check the position of the recording paper to ensure that the recording paper is aligned with the paper outlet.



CAUTION:

- **Must use the thermo-sensitive paper that meets requirements; otherwise, it will lead to recording failure, bad-quality record or damage of thermo-sensitive printing head.**
 - **Do not pull out the recording paper during recorder printing, otherwise the recording meter may be damaged.**
 - **Unless for paper replacement or fault remedy, don't keep the recorder door open.**
-

19.8. Clearing Jam Paper

While the sound of recorder operation or printing of recording meter is abnormal, please first check whether there is paper jam in the recording meter. If so, please clear it as per following steps:

1. Open the recorder door;
2. Pull out the recording paper, and cut off the wrinkle part;
3. Load recording paper once again and close the recording meter door.

19.9. Cleaning Recorder

After long-time service, some paper scrap and impurity will accumulate on the printing head, and affect printing quality as well as the service life of printing head and roll shaft. The recorder can be cleaned according to the following methods:

1. Before cleaning, the measures such as wearing anti-static wrist strap shall be adopted to avoid the damage to recording meter resulting from static;

2. Open the recorder door and pull out recording paper;
3. Use a tampon with some alcohol to sweep slightly the surface of thermo-sensitive parts of printing head;
4. After the alcohol entirely vaporizes, load recording paper once again and close the recorder's door.



CAUTION:

- **Don't use any article that can damage the thermo-sensitive parts of recorder during cleaning.**
 - **Don't heavily press the printing head of recorder.**
-

Chapter 20 Other Functions

20.1. Analog Signal Output

The monitor has an auxiliary output port that can provide “analog signal output”. Connect the monitor to equipment such as an oscillograph, and then do some associated setup, after that you can output the analog signal to the oscillograph through the port.

The setting ways of analog signal output are as below:

1. Select **【Main Menu】** quick key→from **【System】** column to select **【Maintenance】** →input maintenance password→Enter.
2. Select **【Module】** submenu→ **【Auxiliary Output】** submenu.
3. Select **【Analog Output】** , set the analog output signal as required.



CAUTION:

- **Analog output function is seldom used in clinic. If you need t know more detailed information, please contact the service personnel.**
-

20.2. Network Settings

20.2.1. Setting the type of network

The steps for setting the network type are as follows:

1. Select **【Main Menu】** quick key→from **【System】** column to select **【Maintenance】** →input maintenance password→Enter.
2. Select **【Network Setup】** submenu → **【Network Type】** .
3. Set to **【LAN】** or **【WLAN】** according to the network type used.

20.2.2. Setting the Wired Network

To set the wired network, follow this procedure:

1. Select **【Main Menu】** quick key→from **【System】** column to select **【Maintenance】** →input maintenance password→Enter.

2. Select **【Network Setup】** submenu → **【LAN】** submenu.
3. Select how to get the IP address:
 - ◆ **【Obtain IP Address Automatically】** : The monitor automatically gets the IP address.
 - ◆ **【Use the Following Address】** : you need to input the **【IP Address】**, **【Subnet mask】** and **【Gateway】** .

20.2.3. Setting the Wireless network

To set the wireless network, follow this procedure:

1. Select **【Network Setup】** quick key.
2. The interface will show the surrounding wireless network, and you can choose to use the wireless network according to your needs.
3. If you need to manually add a wireless network, you can select the **【Add Net】** button at the bottom of the menu to set the **【SSID】** , **【Security】** , **【Password】** and **【DHCP】** of the network:
 - ◆ **【SSID】** : Set name of the network.
 - ◆ **【Security】** : Set the encryption method.
 - ◆ **【Password】** : Set the password to enter the network.
 - ◆ **【DHCP】**: Open **【DHCP】**, and the monitor will automatically acquire the IP address; if close **【DHCP】** , you need to manually enter the IP address, subnet mask and gateway.

20.2.4. Setting the wireless network frequency and antenna type

The steps for setting the wireless network frequency and antenna type are as follows:

1. Select **【Main Menu】** quick key→from **【System】** column to select **【Maintenance】** →input maintenance password→Enter.
2. Select **【Network Setup】** submenu → **【WLAN】** submenu.
3. Set the **【Frequency】** and **【Antenna】** of the wireless network according to the usage.
 - ◆ **【Frequency】** : **【5G】** or **【2.4G】** .

◆ **【Antenna】** : **【Build-in】** or **【External】** .

4. Restart the monitor

20.2.5. Connecting the Central Monitoring System (CMS)

The monitor can be connected to the central monitoring system via wired network or wireless network.

20.2.5.1. Setting the CMS IP Address

To set the IP address of CMS, follow this procedure:

1. Select **【Main Menu】** quick key→from **【System】** column to select **【Maintenance】** →input maintenance password→Enter.
2. Select **【Network Setup】** submenu → **【CMS】** submenu.
3. Set the IP address of the CMS. The monitor can be received by the CMS of the IP address.

20.2.5.2. Setting the device number of the monitor

The device number of the networked monitor will be displayed when the central monitoring system and other beds are monitored. The steps for setting the device number of the monitor are as follows:

1. Select **【Main Menu】** quick key→from **【System】** column to select **【Maintenance】** →input maintenance password→Enter.
2. Select **【Network Setup】** submenu → **【CMS】** submenu.
3. Set **【Device No.】** of the monitor.

Please refer to *the Central Monitoring System User's Manual* for detailed instructions.



NOTE: This monitor can only be connected to the central monitoring system

provided by the manufacturer. Do not try to connect the monitor to other central monitoring system.

20.3. HL7 Settings

The real-time data, waveforms, and alarms of the monitor can be transmitted to the hospital's monitoring system through the HL7 protocol. The operating steps are as follows:

1. Select **【Main Menu】** quick key→from **【System】** column to select **【Maintenance】** →input maintenance password→Enter.
2. Select **【Network Setup】** submenu → **【HL7】** submenu.
3. Select **【Parameter】** , **【Waveform】** and **【Alarm】** sending function as required.
 - ◆ From **【Physiological data】** column to select monitor as **【Server】** or **【Client】** . If select the monitor as **【Client】** , set the **【IP】** and **【Port】** for the server receiving the real-time data and waveform. And can set **【Interval】** of data.
 - ◆ From **【Alarm Data】** column to select monitor as **【Server】** or **【Client】** . If select the monitor as **【Client】** , set the **【IP】** and **【Server Port】** for the server receiving the real-time data and waveform.

Chapter 21 Battery

21.1. Introduction

The monitor can be fitted with rechargeable battery to ensure the normal use of the monitor in case of intra-hospital patient transfer or whenever the power supply is interrupted. When the monitor is switched on with AC power, the battery can be charged regardless of whether the monitor is switched on or not. Since we do not provide external charging equipment, the battery can only be charged in the monitor. In case of sudden power failure, the system will automatically use battery to supply power to the monitor, thus not causing interruption of monitoring work.

On-screen battery symbols indicate the battery status as follows:



Indicate that the battery works correctly. The solid portion represents the battery's charge.



Indicate that the battery is almost depleted and needs to be charged immediately. Otherwise, the monitor will be automatically shut down. In this case, the monitor sends out an alarm message.



Indicate that no battery is installed.

The power supply of battery can only function for a certain period. Excessively low voltage of battery will trigger a high priority technical alarm **【Battery Low】**. At this moment, the monitor shall immediately connect with alternating current power supply to charge the battery.

In case of long-term monitoring, a backup battery shall be installed and used after the AC power is plugged in. The AC power plug must be plugged into the special interface of the hospital.

21.2. Installing a Battery

The battery of this monitor must be installed and replaced by maintenance personnel trained and authorized by our company.

21.3. Battery Guidelines

The service life of the battery depends on the frequency and time of use. If

lithium batteries are properly maintained and stored, their service life is about 3 years. If batteries are used improperly, their life may be shorter. We recommend replacing lithium batteries every 3 years.

In order to ensure the maximum capacity of the battery, please pay attention to the following instructions:

- ◆ The battery performance must be checked every two months. Before the monitor is repaired or when you suspect that the battery is the source of the fault, battery performance inspection is also required.
- ◆ When the battery is used or stored for three months or when the running time of the battery is significantly shortened, the battery performance is optimized once.
- ◆ If the monitor is not used for a long time, please optimize the battery performance every three months. Because not taking out the battery will shorten the battery life.
- ◆ If the lithium battery is put on hold when its charge is 50% of its full charge, the storage life of the lithium battery is about 6 months. After 6 months, the lithium battery must be used up before being charged to full capacity. The monitor is powered by the lithium battery, and the battery is taken out of the monitor and then put on hold when the battery is 50% of the full charge.



WARNING:

- **Keep the battery out of the reach of children.**
 - **Use only batteries specified in the manufacturer.**
 - **If the battery shows signs of damage or signs of leakage, replace it immediately.**
- Do not use a faulty battery in the monitor.**
-

21.4. Battery Maintenance

21.4.1. Optimizing Battery Performance

A battery should be optimized before it is used for the first time. A battery

optimizing cycle is one uninterrupted charge of the battery, followed by an uninterrupted battery discharge and charge. Batteries should be optimized regularly to maintain their lifetime.



CAUTION:

- **Over time and with the use of batteries, the actual storage capacity of batteries will decrease. For old batteries, the full capacity icon does not mean that the battery storage capacity can still meet the manufacturer's specifications, nor does it mean that the battery power supply time can still meet the manufacturer's specifications. During optimization, if the battery power supply time is obviously shortened, please replace the battery.**
-

To optimize a battery, follow this procedure:

1. Disconnect the monitor from the patient and stop all monitoring and measuring procedures.
2. Connect the monitor to the AC power supply and charge the battery continuously until the battery is full.
3. Remove the AC mains and allow the monitor to run from the battery until it shuts off.
4. Reconnect the monitor to AC power and recharge the battery.
5. The optimizing of the battery is over.

21.4.2. Checking Battery Performance

The performance of a battery may deteriorate over time. To check the performance of a battery, follow this procedure:

1. Disconnect the monitor from the patient and stop all monitoring and measuring procedures.
2. Connect the monitor to AC power and charge the battery continuously until the battery is full.
3. Disconnect AC mains and allow the monitor to run on the battery until it shuts off.
4. The operating time of a battery reflects its performance directly. If the power

supply time of the battery is obviously lower than the time stated in the specification, please consider replacing the battery or contact maintenance personnel.



CAUTION:

- **If the power supply time is too short after the battery is fully charged, the battery may have been damaged or malfunctioned. The power supply time of the battery depends on the equipment configuration and operation. For example, frequent NIBP measurement will also shorten the power supply time of the battery.**
-

21.5. Battery Recycling

When a battery has visual signs of damage, or no longer holds a charge, it should be replaced. Removed the old battery from the monitor and recycle it properly. To dispose of the batteries, follow local laws for proper disposal.



WARNING:

- **Do not disassemble batteries, or dispose of them in fire, or cause them to short circuit. They may ignite, explode, or leak, causing personal injury.**
-

Chapter 22 Maintenance and Cleaning

Use only the materials and methods listed in this section to clean or disinfect the monitor and accessories. We do not provide any guarantee for damages or accidents caused by the use of other materials or methods.

Our company is not responsible for the effectiveness of the listed chemicals or methods as a means of controlling infection. Please consult the hospital's Infection Control Officer or Epidemiologist.

22.1. Introduction

Keep your equipment and accessories free of the dust and dirt. To avoid damage to the equipment, follow these rules:

- ◆ Please dilute the detergent and disinfectant according to the manufacturer's instructions, or use as low a concentration as possible.
- ◆ Do not immerse the monitor in liquid.
- ◆ Do not pour liquid on the monitor or accessories.
- ◆ Do not allow liquid to enter the cabinet.
- ◆ Abrasive materials (such as steel wool or silver polishing agent) and any strong solvent (such as acetone or detergent containing acetone) as well as liquids with strong conductivity (such as physiological saline) shall not be used.
- ◆ Please do not clean or disinfect the equipment when it is running or when it is exposed to direct sunlight.
- ◆ Ensure that all parts of the equipment are completely dry after cleaning and disinfection.



WARNING:

- **Disconnect the power cord from the socket before cleaning the monitor.**
-
-



CAUTION:

- **If you accidentally pour liquid on the monitor or accessories, please contact the**

maintenance personnel or our company immediately. Please do not use the equipment until it has been detected and confirmed that it can continue to be used.

- **To clean or disinfect reusable accessories, please refer to the instructions provided with the accessories.**

22.2. Cleaning of the Monitor

Monitors should be cleaned regularly. If there is heavy pollution or lots of dust and sand in your place, the monitor should be cleaned more frequently. Before cleaning the monitor, consult the hospital's regulations for cleaning the monitor.

Use a soft cloth that cannot bear balls, wet and clean it with an appropriate amount of water or alcohol-based detergent (such as 70% ethanol). Do not use strong solvents such as acetone or tichloroethylene. Be careful when cleaning the monitor's screen, which is more sensitive than the case. The interface and metal parts of the equipment should be avoided. After cleaning, the equipment should be placed in a ventilated and cool environment to dry.



CAUTION:

- **Interfaces and metal parts may be corroded after contacting with detergent.**

22.3. Disinfection

You can disinfect the equipment according to the hospital's disinfection procedures. Clean the monitor before disinfection. The following table lists the recommended disinfectants:

Name	Type	Manufacturer
Isopropyl alcohol, 70%	Liquid	-
Sodium hypochlorite, 0.5%	Liquid	-
Alcohol, 70%	Liquid	-
Hydrogen peroxide, 3%	Liquid	-

22.4. Cleaning and Sterilizing of Accessories

For cleaning, disinfection and sterilization methods of reusable accessories such as sensors, cables and lead wires, please refer to the instructions of relevant accessories. Please refer to this section if the attachment does not include instructions.

22.4.1. Safety information



CAUTION:

- **Do not immerse accessories in water or disinfectant.**
- **Do not wet the pins of the accessories.**
- **Frequent disinfection of accessories can cause damage to them. It is suggested that according to hospital regulations, accessories should be disinfected only when necessary.**
- **When cleaning and disinfecting NIBP airpipe, liquid should be prevented from entering the airpipe.**
- **Use only the detergents and disinfectants specified in this manual.**

22.4.2. Cleaning of the accessories

Use a soft cloth that cannot bear balls, wet and clean the accessories with an appropriate amount of water or alcohol-based detergent (such as 70% ethanol). After cleaning, place the accessories in a cool and ventilated environment to dry.

22.4.3. Disinfection of the accessories

You can disinfect the accessories of the monitor according to the disinfection procedures of the hospital. Recommended disinfectants include:

Name	Type	Manufacturer
Isopropyl alcohol, 70%	Liquid	-
Sodium hypochlorite, 10%	Liquid	-
Alcohol, 70%	Liquid	-
Hydrogen peroxide, 3%	Liquid	-
Glutaraldehyde solution, 2%	Liquid	-

22.5. Sterilization

Sterilization of this monitor, related products or accessories is not allowed unless otherwise stated in the accompanying instructions.

Chapter 23 Maintenance



WARNING:

- **Failure on the part of the responsible individual hospital or institution employing the use of this equipment to implement a satisfactory maintenance schedule may cause undue equipment failure and possible health hazards.**
 - **The safety checks or maintenance involving any disassembly of the equipment should be performed by professional servicing personnel. Otherwise, undue equipment failure and possible health hazards could result.**
 - **If necessary, please contact the manufacturer for product circuit diagrams, parts lists, calibration instructions or other equipment maintenance related information.**
 - **If there is a problem with the monitor, please contact the maintenance personnel or us.**
-

23.1. Inspection

Before use, after continuous use for 6-12 months, maintenance or upgrade, qualified maintenance personnel should conduct a comprehensive inspection to ensure the normal operation and work of the monitor.

Items to be inspected shall include:

- ◆ The environment and power supply meet the requirements.
- ◆ There is no mechanical damage to the monitor and accessories.
- ◆ The power cord has no abrasion and good insulation performance.
- ◆ Use the specified accessories.
- ◆ The alarm system functions normally.
- ◆ The recorder works normally and the recording paper meets the specified requirements.
- ◆ The performance of the battery.
- ◆ Various monitoring functions are in good working condition.
- ◆ Grounding impedance and leakage current meet the requirements.

If any damage or abnormal phenomenon is found, please do not use the monitor and immediately contact the medical engineer of the hospital or the maintenance personnel of the company.

23.2. Maintenance Schedule

The following tasks, except visual inspection, startup detection, touch screen calibration, battery inspection and recorder inspection, can only be completed by professional maintenance personnel. Please contact the maintenance personnel in time when the following maintenance is required. Before testing or maintenance, the equipment must be cleaned and disinfected.

Check / Maintenance item		Recommended frequency
Preventative Maintenance Tests		
Visual inspection		Every day, before first use
ECG	HR detect	<ol style="list-style-type: none"> When the user suspects that the measured value is inaccurate. After the relevant modules are repaired or replaced. For DM and CO2 module, at least once every a year. For other module, at least once every two years.
	Calibration detect	
RESP	RR detect	
SpO2	SpO2 detect	
	PR detect	
TEMP	TEMP detect	
NIBP	Leakage detect	
	Static pressure detect	
	Pressure calibration	
CO2	CO2 gas detect	
IBP	Static pressure detect	
	Pressure calibration	
DM	Drip rate detect	
Nurse call detect		When you suspect that the function is not normal.
Analog output test		
Defibrillation synchronization test		
Electrical Safety Tests		
Select test items based on IEC		1. After repairing or replacing the power

60601-1		<p>module.</p> <ol style="list-style-type: none"> 2. Or after the monitor falls. 3. At least once every two years or as required.
Other Tests		
Power-on test		Before use.
Network print test		<ol style="list-style-type: none"> 1. During the first installation. 2. After repairing or replacing the printer.
Recorder check		<ol style="list-style-type: none"> 1. Before the first use. 2. After repairing or replacing the recorder.
Battery check	Functionality test	<ol style="list-style-type: none"> 1. During the first installation. 2. After replacing the battery
	Performance test	Every two months or when the running time of the battery is significantly shortened.

23.3. Disposing of the Monitor

After the equipment reaches its service life, please dispose of the monitor and its accessories according to local regulations.



WARNING:

- For the disposal of parts and accessories, if there is no corresponding regulation, local regulations on disposal of hospital waste can be followed.

Chapter 24 Accessories



WARNING:

- Use only the accessories specified in this chapter. Use of other accessories may damage the monitor or fail to meet the specifications claimed in this manual.
 - The accessories listed in this chapter must be used together with the monitoring equipment of our company. The user has the responsibility to read the operating instructions of the equipment (including accessories) or contact us for consultation to confirm the matching between the accessories and the equipment. Otherwise, it may cause injury to the patient.
 - Disposable accessories can only be used once. Repeated use may cause performance degradation or cross infection.
 - Do not open the disposable or sterilized accessory package too early, so as not to cause the accessory to fail or become contaminated.
-



CAUTION:

- If the use or storage environment of accessories exceeds the specified temperature or humidity range, the performance of accessories may not meet the claimed specifications. If the performance of accessories is degraded due to aging or environmental conditions, please contact customer service personnel.
 - If there are signs of damage to the package of the accessory or the accessory itself, please do not use the accessory.
 - Do not use the accessory if it expires.
 - Disposable accessories must be handled in accordance with local regulations or hospital systems.
-



NOTE:

- For accessories with safe service life, see the package of accessories for service

life.

- Please refer to the package of accessories for sterilization accessories. If the package of the accessories of the sterilization package is damaged, please do not use it.

24.1. Recommended Accessories

➤ ECG

Accessories	Specification	Model / PN
ECG cable	3-lead,IEC,Snap (12PIN)	15-031-0013
	5-lead,IEC,Snap (12PIN)	15-031-0002
	5-lead,IEC,Clip (12PIN)	15-100-0370
	6-lead,IEC,Snap (12PIN)	15-031-0051
	12-lead,IEC,Snap (12PIN)	15-031-0001
	5-lead,IEC,Clip (12PIN)(plug-in)	15-031-0022
	3-lead,AHA,Snap (12PIN)	15-031-0014
	5-lead,AHA,Snap (12PIN)	15-031-0004
	6-lead,AHA,Snap (12PIN)	15-031-0050
	12-lead,AHA,Snap (12PIN)	15-031-0003
	3-lead,AHA,Snap (12PIN)(plug-in)	15-100-0196
	5-lead,AHA,Clip (12PIN)(plug-in)	15-031-0021
	5-lead,AHA,Snap (12PIN)(plug-in)	15-100-0197
	Electrode with snap clips	Reusable

➤ SpO₂

Accessories	Specification	Model / PN
SpO ₂ sensor	Ear clip SpO ₂ sensor	15-100-0325
Tongue clip	Reusable ,Tongue clip (small)	15-100-0079
	Reusable ,Tongue clip (large)	15-100-0189
SpO ₂ Extension cable	Reusable	15-100-0357

➤ **TEMP**

Accessories	Specification	Model / PN
TEMP Probe	Reusable, Surface	15-031-0005
	Reusable, Coelom	15-031-0012

➤ **NIBP**

Accessories	Specification	Model / PN
NIBP cuff	Disposable cuff, 3-5.5CM	15-100-0164
	Disposable cuff, 4-8CM	15-100-0165
	Disposable cuff, 6-11CM	15-100-0166
	Disposable cuff, 7-13CM	15-100-0167
	Disposable cuff, 9-14.5CM	15-100-0168
NIBP air pipe	Reusable	15-031-0008

➤ **CO₂**

BLT Mainstream CO₂

Accessories	Model / PN
CO ₂ sensor	15-100-0199
Airway adapter	15-100-0212
Airway adapter	15-100-0213

BLT Microflow CO₂

Accessories	Model / PN
CO ₂ filter	15-100-0354
CO ₂ sampling tube	15-100-0187
CO ₂ sensor	15-100-0185
CO ₂ L-type 3-way stopcock	15-100-0074
CO ₂ pipe	15-100-0035
CO ₂ sampling tube	15-100-0188
CO ₂ T-type 3-way stopcock	15-100-0343

Masimo Mainstream CO₂

Specification	Model / PN
CO ₂ sensor	REF:200101
Airway adapter	REF:106220/PN:4499
Airway adapter	REF:105250

Masimo Microflow CO₂

Accessories	Model / PN
CO ₂ module	4410
HH, Airway Adapter Set	3827
HH, Airway Adapter Set (3m)	3828
HH, Airway Adapter Set	3829
LH, Nasal/Oral Cannula	3822
LH, Nasal/Oral Cannula	3823
HH, Nasal Cannula	3830
HH, Nasal Cannula	3831
HH, Nasal Cannula	3832
HH, Nasal/Oral Cannula	3835
HH, Nasal/Oral Cannula	3836
HH, Nasal Cannula with O ₂ delivery	3833
HH, Nasal Cannula with O ₂ delivery	3834
HH, Nasal Cannula/Oral with O ₂ delivery	3837
HH, Nasal Cannula/Oral with O ₂ delivery	3838

CO₂ extension cable

Accessories	Model / PN
Reusable, CO ₂ extension cable	15-031-0010
Reusable, CO ₂ extension cable	15-031-0011

➤ IBP

Accessories	Model / PN
IBP sensor	PT-1/15-100-0053

Accessories	Model / PN
IBP cable	15-100-0029
IBP extension cable (4PIN to 6PIN)	15-031-0023
IBP cable	15-100-0098
IBP sensor	PT-01/15-100-0097
IBP cable	15-100-0136
IBP cable	15-100-0137
IBP cable	15-100-0143

➤ **DM module**

Accessories	Model / PN
DM module	16-100-0113

➤ **C.O.**

Accessories	Model / PN
C.O. interface cable (6PIN)	15-100-0148
Sensor cable	SP4042
Sensor cap	SP5045
Tricyclic syringe	15-100-0169/RFF: 620161

Appendix A Product Specifications

A.1 Safety Specifications

The monitor is Classified according to the IEC60601-1 is as follows:

Parts	Classification of protection against electric shock	Degree of protection against electric shock	Degree of protection against ingress of liquid	Degree of protection against hazards of explosion	Recommended disinfection and sterilization methods	Mode of operation
Mainframe	I	No mark	IP21	Not suitable	See Chapter 22 Maintenance and Cleaning of this manual for details.	Continuous
Fixed parameter (ECG, TEMP, RESP, NIBP, SpO2)	NA	CF				
IBP		BF				
C.O.						
CO2						
DM						

Note:

I: Class I, internally and externally powered equipment.

When you doubt about the protecting earth integrity or protecting earth lead of the equipment, you'd better change the equipment to internally powered equipment.

CF: Type CF applied part.

BF: Type BF applied part.

NA: Not applicable

Not suitable: Equipment is not suitable for use in the presence of flammable anesthetic mixture with air or with oxygen or nitrous oxide.

A.2 Environmental Specifications

Operating temperature	Mainframe	0°C ~ 40°C
	CO2 module (external)	5°C ~ 40°C
Operating humidity		15% ~ 95% (non-condensing)
Operating atmospheric pressure	Mainframe	57kPa ~ 107.4kPa
	CO2 module (external)	86 kPa ~ 106 kPa
Transportation and storage temperature	Mainframe	-20°C ~ +60°C
	CO2 module (external)	-40°C ~ +70°C
Transportation and storage humidity	Mainframe	10% ~ 95% (non-condensing)
	CO2 module (external)	<90% (non-condensing)
Transportation and storage atmospheric pressure	Mainframe	16.0kPa ~ 107.4kPa
	CO2 module (external)	86 kPa ~ 106 kPa



CAUTION:

- The equipment must be used under the specified environmental specifications, otherwise it will not meet the technical specifications claimed in this manual and may lead to unexpected consequences such as equipment damage. If the performance of the equipment changes due to aging or environmental conditions, please contact the maintenance personnel.

A.3 Physical Specifications

Model	Weight	Size (W×H×D)	Remark
S12 Vet	<4kg	175mm * 320mm* 262mm	Including screen, stationary parameter module, a lithium battery, a recorder, without accessories.

A.4 Power Specifications

A.4.1 External power supply

Input voltage	AC (100-240) V(±10%)
Frequency	50Hz/60Hz
Input power	100VA
Standard requirements	According to IEC 60601-1 and IEC 60601-1-2

A.4.2 Battery

Battery (Standard configuration)	
Type	Rechargeable lithium ion battery, 11.1 VDC, 2500mAh
Operating time	In a new and fully charged battery at (25°C) ambient temperature, typical configuration (connected to SpO ₂ ; not connected to ECG and TEMP cable, and NIBP works in an automatic measurement mode with a time interval of 30 min; Screen brightness is the factory default value): S12 Vet: ≥4h
Charge time	The monitor is charged to 90% for less than 3 hours and 100% for less than 4 hours when it is turned off. When the monitor is turned on, it is charged to 90% for less than 5 hours and 100% for less than 6 hours.
Turn off delay	5 min-15min (after the low battery alarm first occurs)
Battery (optional configuration)	
Type	Rechargeable lithium ion battery, 11.1 VDC, 5000mAh
Operating time	In a new and fully charged battery at (25°C) ambient temperature, typical configuration (connected to SpO ₂ ; not connected to ECG and TEMP cable, and NIBP works in an automatic measurement mode with a time interval of 30 min; Screen brightness is the factory default value): S12 Vet: ≥8h
Charge time	The monitor is charged to 90% for less than 6 hours and 100% for

	less than 8 hours when it is turned off. When the monitor is turned on, it is charged to 90% for less than 11 hours and 100% for less than 12 hours.
Turn off delay	5 min-15min (after the low battery alarm first occurs)

A.5 Hardware Specifications

A.5.1 Display

Host display		
Type		Color TFT LCD
S12 Vet	Size (diagonal)	12.1 inch
	Resolution	800×600 pixels
External display		
Type	TFT display	

A.5.2 Recorder

Type	BTR50S thermal dot array
Paper width	50 mm±1mm
Recording speed	12.5 mm/s, 25 mm/s, 50 mm/s
Recording waveform	Maximum 3 tracks

A.5.3 Mainframe LED

Alarm lamp	Cyan, yellow and red
Power indicating lamp	1 (Green/Orange) When powered with AC, it lights green while turn on and off the monitor. When powered with battery, the orange light is on when the battery is turned on, and no light is on when the battery is turned off.
Battery charging	1 (yellow), When charging, it is always on, and when it is fully

indicating lamp	charged, the light goes out.
------------------------	------------------------------

A.5.4 Audio indicating

Speaker	Give alarm tone (45-85dB), QRS tones; Support PITCH TONE and multi-level tone modulation; Alarm tones meet the requirements of IEC 60601-1-8.
----------------	---

A.5.5 Input device

Keys	
Physical keys	1 power switch key
Touch screen	Support
Others	
Mouse input	Support (optional)
Keyboard input	Support (optional)
Barcode scanner	Support (optional)
Voice assistant	Support (optional)

A.5.6 Connectors

Power	1 AC power inlet with cable retainer
Wired network	1 standard RJ45 interfaces
USB	2 standard USB 2.0 sockets
VGA	1 standard VGA connector (optional)
Equipotential grounding point	1
Multifunctional (nurse call, defibrillation synchronization and analog output) interface	1 (optional)

A.5.7 Signal Output

Auxiliary output interface (optional)	
Standard	Meet the requirements of IEC 60601-1 for short-circuit protection and leakage current.
Output impedance	Rated 50Ω
ECG analog signals output	
Output signal range	-10V~+10V
Maximum transmission delay	25 ms
Sensitivity	1V/mV±5%
PACE rejection / strengthen	Has PACE rejection function
IBP analog signals output	
Output signal range	-1V~+4V
Maximum transmission delay	35 ms
Sensitivity	1V/100mHg±5%
Nurse call output	
Output voltage range	High level: 3.5~5V, providing a maximum of 10 mA output current; Low level: < 0.5V, receiving a maximum of 5 mA input current.
Isolated voltage	1500 VAC
Signal type	N.C., N.O., Pulse Output (optional);
Rise and drop time	≤1ms
Defibrillator synchronization signal output	
Output impedance	50Ω±10%
Maximum delay	25 ms (from R wave crest to pulse raise)
Amplitude	High level: 3.5~5V, providing a maximum of 10 mA output current; Low level: < 0.5V, receiving a maximum of 5 mA input current.

Pulse width	100ms±10%
Rise and drop time	≤1ms
Alarm output	
Indicates the inherent delay in determining the alarm status.	≤1s
Alarm delay time from the monitor to remote equipment	The alarm delay time from the monitor to remote equipment is ≤ 2s, measured at the monitor signal output connector.
Alarm signal sound pressure level range	Within a distance of one meter, the peak volume range of the audible alarm generated by the equipment is 45 dB (A) ~ 85 dB (A).

A.6 Data Storage

Trend data	Long trend: 1800h, minimum resolution is 10 min
	Medium trend: 180h, minimum resolution is 1 min
	Short trend: 6h, minimum resolution is 5 second.
Parameter alarm event	At least 3000 parameter alarm events and associated parameter waveform at the moment.
ARR events	3000 ARR events, and the parameter waveform related to the time of event occurrence.
NIBP measurement result	At least 2400 groups.
Holographic waveform	At least 72 hours. The specific storage time depends on the waveforms stored and the number of stored waveform.

A.7 Wireless network

Conforming standards	IEEE802.11a/b/g/n
Operating frequency	2.4GHz ~ 2.495 GHz, 5.15GHz ~ 5.35GHz, 5.47GHz ~

	5.725GHz, 5.725 GHz~5.82GHz
Data security	WPA-PSK、WPA2-PSK
Encryption	AES、TKIP

A.8 Measurement Specifications

The product shall meet the following measurement specifications. If there is no special indication, the definition of the index shall preferentially refer to the special standard of the parameter.

A.8.1 ECG

A.8.1.1 Standard

Refer to standards of IEC 60601-2-27
Refer to standards of IEC 60601-2-25

A.8.1.2 Performance indicators

Electrosurgery protection	Cut mode: 300W Coagulate mode: 100W Recovery time: $\leq 10s$ In compliance with the requirements in clause 202.6.2.101 of IEC 60601-2-27.
Lead-off detection current	Measuring electrode: $<100nA$ Driving electrode (RL): $<1 Ua$
Tall T-wave rejection capability	1.5Mv
HR averaging method	Under normal circumstances, the 12 most recent RR intervals are averaged to compute the HR. If the last 3 consecutive RR intervals are greater than 1200ms (i.e., HR is less than 50bpm), the 4 most recent RR intervals are

	<p>averaged to compute the HR.</p> <p>The HR value displayed on the monitor screen is updated every second.</p>
Response to irregular rhythm	<p>Meet the requirements of Clause 201.7.9.2.9.101 b) 4) of IEC 60601-2-27.</p> <p>The heart rate value displayed after the 20-second stabilization period is:</p> <p>Waveform 3a (Ventricular bigeminy): 80bpm; Waveform 3b (Slow alternating ventricular bigeminy): 60bpm Waveform 3c (Rapid alternating ventricular bigeminy): 120bpm Waveform 3d (Bidirectional systoles): 90bpm</p>
Response time to heart rate change	<p>HR change from 80bpm to 120bpm: < 10s.</p> <p>HR change from 80bpm to 40bpm: <10s.</p>
Time to alarm for Tachycardia	<11s
Pace pulse markers	<p>Amplitude: $\pm 2\text{mV} \sim \pm 700\text{mV}$</p> <p>Pulse width: 0.1~2.0ms</p>
Pacemaker pulse rejection capability without overshoot.	Rejection of pacemaker pulses with amplitudes from $\pm 2\text{ mV}$ to $\pm 700\text{ mV}$ and widths from 0.1ms to 2.0ms. Heart rate calculation should not be affected.
Minimum slew rate for pacing pulse detection.	$12.5\text{V/s} \pm 20\%$
Pacing pulse display method in auxiliary output	Suppression
Pacing function switch	Pace markers function can be switched on and off.
Defibrillation output delay	25ms
ECG Analog Output Delay	25ms

A.8.1.3 ECG Measurement

Lead type	3-lead: I, II, III 5-lead: I, II, III, aVR, aVL, aVF, V- 6-lead: I, II, III, aVR, aVL, aVF, Va, Vb 12-lead: I, II, III, aVR, aVL, aVF, V1~V6 Auto: identify leads automatically	
Indication of lead-off shall be provided	Every electrode	
ECG abnormal work indications	Every amplification channel shall have an indication of abnormal ECG operation (polarization).	
Bandwidth (-3dB)	Diagnostic mode: 0.05~150Hz Monitor mode: 0.5~40Hz Operation mode: 1~25Hz ST mode: 0.05~40Hz	
Signal quality display	Expression way: numerical display and waveform color.	
Defibrillation Protection	Breakdown Voltage: 4000V 50Hz/60Hz Anti-defibrillation effect protection: baseline recovery time: 5s (after defibrillation).	
Input signal range	Input signal range	-10.0mV~+10.0Mv
	Electrode offset potential	±500 mV d.c.
Input impedance	≥5.0MΩ	
System noise	≤30μVpp RTI	
Waveform sweep speed	Display	6.25mm/s, 12.5mm/s, 25mm/s, 50mm/s, error ≤±5%
	Recorder	12.5mm/s, 25mm/s, 50mm/s, error ≤±5%
Waveform Gain	Display	×0.25, ×0.5, ×1 (10mm/mV), ×2, ×4, error ≤±5%.
		Auto
	Recorder	×0.25, ×0.5, ×1 (10mm/mV), ×2, ×4, error ≤±5%.
CMRR	Diagnostic mode	≥100 dB
	Monitor, Operation mode	≥110 dB

Calibration voltage	$\leq \pm 5\%$ ($\times 1$)
Input offset current	$< 0.1\mu\text{A}$
Time constant	Monitoring mode: $\geq 0.3\text{s}$
	Diagnostic mode: $\geq 3.2\text{s}$

A.8.1.4 ECG analysis calculation

Measurement parameter	HR, PVCs, ST, QT, and Arrhythmia analysis	
Multi-lead synchronous analysis function	Supports synchronous analysis of at least 2 leads, one of which is the key monitoring lead and the other is the auxiliary lead. It is on except 3-lead mode.	
Smart Lead Switch	Automatic, Manual; Default manual (3-lead mode is fixed as manual) Automatic mode: the algorithm automatically identifies the current smart leads, and the host automatically switches the key monitoring leads according to the identification of the algorithm.	
HR measurement range and accuracy	Measurement range	10~400 bpm
	Resolution	1 bpm
	Accuracy	$\pm 1\%$ or ± 1 bpm, whichever is greater
	Detection sensitivity	0.20mVp-p
ST Display	Display 12-lead ST segment values at the same time and support ST graphic display.	
ST measurement range and accuracy	Measurement range	-2.0mV~2.0mV
	Resolution	0.01mV
	Accuracy	-0.8mV~0.8mV: $\pm 0.02\text{mV}$ or $\pm 10\%$, whichever is greater Other: Unspecified
ST Update period	10s	

PVCs measurement	Indicates the number of PVC in the past minute, ranging from 0/min ~150/min.	
Arrhythmia analysis type	27 (see Table 2)	
QT analysis function	Measurement range	QT: 200ms~700ms QTc: 200ms~700ms deltaQTc: -500ms~500ms QT-HR: Big animal: 15bpm~150bpm Small animal: 15bpm~180bpm
	Resolution	QT: 1ms QTc: 1ms
	Accuracy	QT: ± 30 ms
Sampling rate	1000Hz (The time bias among every channels $\leq 100\mu$ s)	
Amplitude quantisation	≤ 1 uV/LSB	

Table 2 Arrhythmia Events list

No.	Full Name	Prompt information
1	Asystole	Asystole
2	Ventricular Fibrillation/ Ventricular Tachycardia	Vent Fib/Tach
3	Ventricular Tachycardia	V-Tach
4	Ventricular Bradycardia	Vent Brady
5	Extreme Tachycardia	Extreme Tachy
6	Extreme Bradycardia	Extreme Brady
7	R on T	R on T
8	Tachycardia	Tachy
9	Bradycardia	Brady
10	Nonsustained Ventricular Tachycardia	Nonsustained V-Tach
11	Ventricular Rhythm	Vent Rhythm

No.	Full Name	Prompt information
12	Pacer Not Captured	PNC
13	Pacer Not Pacing	PNP
14	Heartbeat Pause	Pause
15	Pauses/min High	Pauses/min High
16	Run PVCs	Run PVCs
17	Couplet	Couplet
18	VentricularBigeminy	Bigeminy
19	VentricularTrigeminy	Trigeminy
20	Frequent PVCs	Frequent PVCs
21	Premature ventricular contraction	PVC
22	Missed Beat	Missed Beat
23	Atrial Fibrillation	A-Fib
24	Atrial Fibrillation End	A-Fib End
25	ECGNoise	ECG Noise
26	Irregular Rhythm	Irregular Rhythm
27	Irregular Rhythm End	Irregular RhythmEnd

A.8.2 RESP

A.8.2.1 Measurement specification

Measurement parameter	RR and respiration waveform
Source	RA-LA, RA-LL (default)
Excitation waveform	64 kHz Error: $\leq \pm 10\%$
Excitation current	$\leq 0.3\text{mA RMS}$
Respiration Apnea Alarm	Fixed high priority alarm Adjustable delay time: 10~60s, error $\pm 3\text{s}$ or $\pm 10\%$
Cardiac interference alert	Fixed high priority alarm

RR measurement range and accuracy	Measurement range	0~150 rpm
	Resolution	1 rpm
	Accuracy	±2 rpm or ±2%, whichever is greater.
Bandwidth	0.2 Hz ~2.5Hz	
Sweep speed	6.25mm/s, 12.5mm/s, 25mm/s, 50mm/s, ±10%	
Baseline impedance range	200~2500Ω (using defibrillator proof cable with resistance of 1kΩ)	
Measuring impedance range	0.3Ω~3Ω	
Gain	×0.25, ×0.5, ×1, ×2, ×4	

A.8.3 NIBP

A.8.3.1 Standard

Refer to standard of IEC80601-2-30

A.8.3.2 Measurement Specification

Measurement parameters	SYS, DIA, MAP,PR
Mode of operation	Manual, Auto, STAT, Sequence
Intervals for periodic measurement time	1min, 2 min, 2.5 min, 3 min, 5 min, 10 min, 15 min, 20 min, 30 min, 1h, 1.5h, 2h, 3h, 4h, 8h
Sequence mode	At least 5 groups are supported, and each group individually sets the interval and number of periodic measurement.
STAT mode cycle time	5 min
Measurement range of cuff pressure	0~300 mmHg
Initial inflation pressure	Big animal: 120~280mmHg, default 160mmHg
	Small animal: 60~280mmHg, default 160mmHg

Sensor calibration time	One year (recommend)	
Unit	mmHg, kPa	
Dynamic pressure measurement range	Systolic	30~270 mmHg
	Diastolic	10~220 mmHg
	Mean	20~235 mmHg
Dynamic Pressure Measurement Error of Simulator	Systolic	35~255mmHg: ± 8 mmHg
	Diastolic	15~195mmHg: ± 8 mmHg
	Mean	22~215mmHg: ± 8 mmHg
Static pressure accuracy	± 3 mmHg (± 0.4 kPa)	
Pressure resolution	1 mmHg or 0.1kPa	
PR measurement range and accuracy	Measurement range	40 ~ 240 bpm
	Accuracy	± 3 bpm or $\pm 3\%$, whichever is greater
Maximum measurement time	<120s	
First overpressure protection point	297 \pm 3 mmHg	
Second overpressure protection point	315 \pm 10 mmHg	

Note: The accuracy of NIBP cannot be determined by using a simulator, but under many conditions, it is still necessary to use a simulator to test its performance (for example, a simulator is required for quality control in the production process), and the simulator of the model specified by the manufacturer shall be used for this performance test.

A.8.4 SpO₂

A.8.4.1 Standard

Refer to the standard of ISO 80601-2-61

A.8.4.2 Specification

Measurement parameter	SpO ₂ , PR, PI and RR, SpO ₂ waveform and respiration waveform.		
Sensitivity	High, Medium, Low		
Measurement range and accuracy	Measurement range	0~100%	
	Simulator measurement error	70%~100%: $\pm 2\%$ 0~69% unspecified	
SpO₂ Update period	Normal	≤ 2 s	
	Maximum	≤ 25 s	
SpO₂ Response time	Sensitivity	High	≤ 8 s
		medium	≤ 11 s
		Low	≤ 15 s
PR	Measurement range	25 bpm ~400 bpm	
	Resolution	1 bpm	
	Accuracy	± 3 bpm	
PI	Measurement range	At least 0.05~20.00%	
	Resolution	0.01%	
	Accuracy	$\pm 0.1\%$ or $\pm 10\%$ of reading, whichever is greater	
RESP (from pleth)	Measurement range	0 rpm ~90 rpm	
	Resolution	1 rpm	
	Accuracy	± 2 rpm	

A.8.5 TEMP

A.8.5.1 Standard

Refer to the standard of ISO 80601-2-56.
--

A.8.5.2 Measurement Specification

Parameter	T ₁ , T ₂ , T _D	
Probe	YSI400 series probe (2252Ω@25°C, accuracy ±0.1°C)	
Measurement site	Surface and coelom	
Measurement range and accuracy	Measurement range	0.0°C ~ 50.0°C (32.0°F ~ 122.0°F)
	Resolution	0.1°C
	Accuracy of circuit	±0.1°C (±0.2°F) (without sensor)
Power supplied to probe	<20μW	
Updated time	Every about 1~2s	
Minimum measurement time	Surface: ≤100s	
	Coelom: ≤80s	

A.8.6 IBP

A.8.6.1 Standard

Refer to the standard of IEC 60601-2-34.

A.8.6.2 Functional specification

Measurement parameters	Dual channels IBP parameters (including systolic blood pressure, diastolic blood pressure, average pressure, PR) and waveforms	
Measurement site	ART/CVP/ICP/PA/Ao/UAP/BAP/FAP//LAP/RAP/UVF/LV/P AWP, additionally, P1 and P2 are arbitrary sites	
Scale	Manual, interval and automatic scale settings	
Unit	mmHg, kPa, cmH ₂ O	
PPV	Measurement range	0%~50%
	Accuracy	±8% or ±10% of reading, whichever is

		greater
	Resolution	1%
Static pressure measurement range and accuracy	Measurement range	-50 mmHg ~+360mmHg
	Resolution	1 mmHg
	Accuracy	±2mmHg or ±2% (whichever is greater, without sensor)
Dynamic pressure measurement range and accuracy	Measurement range	-50 mmHg ~+360mmHg
	Accuracy	±2mmHg or ±2% (whichever is greater, without sensor)
Frequency response	Including sensor	At least d.c.~10Hz
	Only host	At least d.c.~12Hz
IBP zero range	-200mmHg~+200mmHg	
PR	Measurement range	30bpm ~300bpm
	Resolution	1bpm
	Accuracy	±1% or ±1bpm whichever is greater
Pressure sensor	Nominal sensitivity	5uV/V/ mmHg
	Output impedance	300Ω~3000Ω
	Volumetric displacement	<0.04 mm ³ /100 mmHg
	Error	±2%
IBP analog output delay	≤35ms	

A.8.7 CO2

A.8.7.1 Standard

Refer to the standard of ISO 80601-2-55.

A.8.7.2 Functional Specification

Measurement parameter	EtCO ₂ , FiCO ₂ , a CO ₂ waveform and awRR
Measurement method	Mainstream, Sidestream
Unit	mmHg, kPa and %

A.8.7.3 Performance Specification

EtCO₂/FiCO₂ measurement range	BLT Capno_S	0%~19.7% (0mmHg~150mmHg)
	Resironics LOFLO C5	0%~19.7% (0mmHg~150mmHg)
	BLT Capno_M	0%~19.7% (0mmHg~150mmHg)
	Resironics CAPNOSTA 5	0%~19.7% (0mmHg~150mmHg)
	Masimo ISA Capno	0%~25% (0mmHg~190mmHg)
	Masimo IRMA	0%~25% (0mmHg~190mmHg)
EtCO₂/FiCO₂ measurement accuracy	± (0.43% + 8% of reading)	
Preheating time	BLT Capno_S	97% of the design error can be reached within 45s, and the design error can be reached within 2 min.

	Respironics LOFLO C5	<20s
	Masimo ISA Capno	<10s (Report concentration and achieve highest accuracy)
	BLT Capno_M	97% of the design error can be reached within 8s, and the design error can be reached within 20s.
	Respironics CAPNOSTA 5	<15s
	Masimo IRMA	<10s
EtCO₂/FiCO₂ display resolution	0.1% or 1mmHg	
awRR measurement range	BLT Capno_S	3~150 bpm
	Respironics LOFLO C5	2~150 bpm
	Masimo ISA Capno	0~150 bpm
	BLT Capno_M	3~150 bpm
	Respironics CAPNOSTA 5	0~150 bpm
	Masimo IRMA	0~150 bpm
awRR measurement accuracy	±1 bpm	
Sampling frequency and accuracy of gas (only sidestream)	BLT Capno_S	50±10mL/min
	Respironics LOFLO C5	50±10mL/min
	Masimo ISA Capno	50±10mL/min
Response time	BLT Capno_S	<3s (including delay time and rise time)
	Respironics LOFLO C5	<3s (including delay time and rise time)

	Masimo ISA Capno	<3s (including delay time and rise time)
	BLT Capno_M	About 70ms (rising time)
	Respironics CAPNOSTA 5	<60ms (rising time)
	Masimo IRMA	<90ms (rising time)

A.8.7.4 The effects on CO₂ measuring values caused by the interfering gases

➤ BLT Capno_S & BLT Capno_M

The accuracy of CO₂ is affected by interfering gases and water vapor. For example, N₂O, a halide-containing anesthetic gas can raise the CO₂ reading (about 2%-10%), and helium and oxygen can reduce the CO₂ reading (1%-10%), so in the presence of interfering gas, the user should send relevant command to the module (the instrument's compensation menu to adjust the interference gas data), so that the module (instrument) can meet the nominal accuracy requirements.

➤ Respironics LOFLO C5

Gas or Vapor	Gas Level	Quantitative Effects
Nitrous oxide	60%	No Additional Effect
Halothane	4%	No Additional Effect
Enflurane	5%	No Additional Effect
Isoflurane	5%	No Additional Effect
Sevoflurane	5%	No Additional Effect
Xenon	80%	Negatively bias Carbon Dioxide values by up to an additional 5 mmHg at 38 mmHg
Helium	50%	No Additional Effect
Metered dose inhaler propellants	Unspecified	Unspecified
Desflurane	15%	Concentrations greater than 5% will

		positively bias Carbon Dioxide values by up to an additional 3 mmHg at 38 mmHg.
Ethanol	0.1%	No Additional Effect
Isopropanol	0.1%	No Additional Effect
Acetone	0.1%	No Additional Effect
Methane	1%	No Additional Effect

➤ **Masimo ISA Capno & Masimo IRMA**

Gas	Gas level	CO2		Agents	N2O
		ISA CO2	ISA AX+ ISA OR+		
N2O ⁴⁾	60 vol%	– ²⁾	– ¹⁾	– ¹⁾	– ¹⁾
HAL ⁴⁾	4 vol%	– ¹⁾	– ¹⁾	– ¹⁾	– ¹⁾
ENF, ISO, SEV ⁴⁾	5 vol%	+8% of reading ³⁾	– ¹⁾	– ¹⁾	– ¹⁾
DES ⁴⁾	15 vol%	+12% of reading ³⁾	– ¹⁾	– ¹⁾	– ¹⁾
Xe (Xenon) ⁴⁾	80 vol%	–10% of reading ³⁾		– ¹⁾	– ¹⁾
He (Helium) ⁴⁾	50 vol%	–6% of reading ³⁾		– ¹⁾	– ¹⁾
Metered dose inhaler propellants ⁴⁾	Not for use with metered dose inhaler propellants				
C2H5OH (Ethanol) ⁴⁾	0.3 vol%	– ¹⁾	– ¹⁾	– ¹⁾	– ¹⁾
C3H7OH (Isopropanol) ⁴⁾	0.5 vol%	– ¹⁾	– ¹⁾	– ¹⁾	– ¹⁾
CH3COCH3 (Acetone) ⁴⁾	1 vol%	– ¹⁾	– ¹⁾	– ¹⁾	– ¹⁾
CH4 (Methane) ⁴⁾	3 vol%	– ¹⁾	– ¹⁾	– ¹⁾	– ¹⁾
CO (Carbon	1 vol%	– ¹⁾	– ¹⁾	– ¹⁾	– ¹⁾

monoxide) ⁵⁾					
NO (Nitrogen monoxide) ⁵⁾	0.02 vol%	– ¹⁾	– ¹⁾	– ¹⁾	– ¹⁾
O ₂ ⁵⁾	100 vol%	– ²⁾	– ²⁾	– ¹⁾	

Note 1: Negligible interference, effect included in the specification “Accuracy, all conditions” above.

Note 2: Negligible interference with N₂O / O₂ concentrations correctly set, effect included in the specification “Accuracy, all conditions” above.

Note 3: Interference at indicated gas level. For example, 50 vol% Helium typically decreases the CO₂ readings by 6%. This means that if measuring on a mixture containing 5.0 vol% CO₂ and 50 vol% Helium, the actual measured CO₂ concentration will typically be $(1-0.06) * 5.0 \text{ vol\%} = 4.7 \text{ vol\% CO}_2$.

Note 4: According to the EN ISO 80601-2-55:2011 standard.

Note 5: In addition to the EN ISO 80601-2-55:2011 standard.

➤ Respironics CAPNOSTA 5

Gas or Vapor	Gas Level
Nitrous oxide	60%
Halothane	4%
Enflurane	5%
Isoflurane	5%
Sevoflurane	5%
Xenon	80%
Helium	50%
Metered dose inhaler propellants	Unspecified
Desflurane	15%
Ethanol	Unspecified
Isopropanol	Unspecified
Acetone	Unspecified
Methane	Unspecified

Additional notes regarding cross-sensitivity compensation errors:

Xenon: The presence of Xenon in the exhaled breath will negatively bias Carbon Dioxide

values by an additional 5 mmHg at 38 mmHg.

Desflurane: The presence of desflurane in the exhaled breath at concentrations greater than 5% will positively bias Carbon Dioxide values by up to an additional 3 mmHg at 38 mmHg.

Ethanol, Isopropanol, Acetone, Methane: CO₂ accuracy will not be affected by the presence of 0.1% ethanol, 0.1% isopropanol, 0.1% acetone or 1% methane.

Quantitative effects of humidity and condensation: Full accuracy specifications will not be maintained for all non-condensing humidity levels.

A.8.8 C.O.

C.O.	Measurement range	0.1 L/min to 20 L/min
	Accuracy (simulator)	±5% or ±0.1 L/min, whichever is greater(without sensor)
	Resolution	0.1 L/min
TB	Measurement range	23.00°C ~ 43.00°C
	Accuracy	±0.1°C(without sensor)
	Resolution	0.01°C
TI	Measurement range	-1.0°C ~ 27.0°C
	Accuracy	±0.1°C(without sensor)
	Resolution	0.1°C

A.8.9 DM

A.8.9.1 Functional Specification

Liquid stop function	Alarm and stop liquid when drip rate is abnormal.
	Alarm and stop liquid when infusion is completed.
	When the module is powered off, the liquid stop clip is opened without affecting the infusion.

Unit	Drops/min, mL/h, can be automatically converted (for conversion, 1mL of conventional tube =20 drops is mainly used.)
-------------	--

A.8.9.2 Performance Specification

Drip rate measurement range	5~200 Drops/min (1mL of conventional tube =20 drops)
Drip accuracy	±2 and ±2% (whichever is greater)

A.9 Alarm Specification

If no special instructions are given in the following specifications, the adjustable range of the alarm limit is the same as the measuring range of the signal.

A.9.1 ECG

Alarm limit	Range	Step
ST High	(low limit +0.01 mV) ~2.00mV	0.01 mV
ST Low	-2.00 mV ~ (high limit -0.01 mV)	
HR High	(HR low limit +1bpm) ~400bpm	1bpm
HR Low	10bpm~ (HR high limit -1bpm)	
QTc High	200ms~700ms	1ms
ΔQTc Low	-500ms~500ms	

A.9.2 RESP

Alarm limit	Range	Step
RR High	(low limit +1 rpm) ~150rpm	1rpm
RR Low	0rpm~ (high limit -1rpm)	

A.9.3 NIBP

Alarm limit	Range	Step
-------------	-------	------

Alarm limit	Range	Step
NIBP-S-High	(low limit+1 mmHg) ~270 mmHg	1mmHg
NIBP-S-Low	30 mmHg ~ (high limit-1 mmHg)	
NIBP-M-High	(low limit+1mmHg) ~235 mmHg	1mmHg
NIBP-M-Low	20 mmHg ~ (high limit-1 mmHg)	
NIBP-D-High	(low limit+1mmHg) ~220 mmHg	1mmHg
NIBP-D-Low	10 mmHg ~ (high limit-1 mmHg)	

A.9.4 SpO2

Alarm limit	Range	Step
SpO2 High	(low limit+1%) ~100%	1%
SpO2 Low	(SpO2 Desat +1%) ~ (high limit-1%)	
SpO2 Desat	0%~ (low limit-1%)	
PR High	(PR low limit+1bpm)~400bpm	1bpm
PR Low	10bpm~ (PR high limit-1bpm)	

A9.5 TEMP

Alarm limit	Range	Step
T1/T2 High	(low limit+0.1°C) ~50.0°C	0.1 °C
T1/T2 Low	0 °C~ (high limit-0.1°C)	0.1 °C
TD High	0°C~5.0°C	0.1 °C

A.9.6 IBP

Alarm limit	Range	Step
IBP-M-High	(low limit +1mmHg) ~360mmHg	1mmHg
IBP-M-Low	-50mmHg~ (high limit -1mmHg)	
IBP-D-High	(low limit +1mmHg) ~360mmHg	1mmHg
IBP-D-Low	-50mmHg~ (high limit -1mmHg)	
IBP-S-High	(low limit +1mmHg) ~360mmHg	1mmHg

Alarm limit	Range	Step
IBP-S-Low	-50mmHg~ (high limit -1mmHg)	

A.9.7 CO₂

Alarm limit	Range	Step
Apnea delay time	20 s~60 s	5s
EtCO ₂ High	(low limit+1mmHg) ~152mmHg	1 mmHg
Et CO ₂ Low	0mmHg~ (high limit-1mmHg)	
Fi CO ₂ High	0~152mmHg	1 mmHg
awRR High	(low limit+1bpm) ~150 bpm	1 bpm
awRR Low	0bpm~ (high limit-1bpm)	

A.9.8 C.O.

Alarm limit	Range	Step
TB High	(low limit +0.1°C) ~43.0°C	0.1 °C
TB Low	23.0 °C~ (high limit -0.1°C)	0.1 °C

Appendix B EMC and Radio Regulatory Compliance

B.1 EMC

The monitor complies with IEC 60601-1-2. All accessories listed in the accessories listed in the accessories of this manual meet the requirements of IEC 60601-1-2 when used with this equipment.



CAUTION:

- **The monitor conforms to the electromagnetic compatibility requirements in IEC 60601-1-2, ISO 80601-2-55, IEC 80601-2-30, IEC 80601-2-49, ISO 80601-2-61, IEC 60601-2-34 standards.**
 - **The user shall install and use according to the electromagnetic compatibility information provided by the accompanying documents.**
 - **Portable and mobile RF communication equipment may affect the performance of this monitor, and strong electromagnetic interference should be avoided during use, such as close to mobile phones, microwave ovens, etc.**
 - **The guidelines and the manufacturer's statement are detailed in the appendix.**
 - **The device needs special precautions regarding EMC and needs to be installed and put into service according to the EMC information provided below.**
 - **Portable and mobile communication equipment may affect the performance of this monitor.**
 - **Other devices that have RF transmitter or source may affect this device (e.g. cell phones, PADs, PCs with wireless function).**
-



WARNING:

- **The monitor should not be used close to or stacked on top of other equipment. If it must be used close to or stacked on top of other equipment, it should be observed and verified that it can operate normally under its used**

configuration.

- **Class A equipment is intended to be used in industrial environment. Due to conduction disturbance and radiation disturbance of this monitor, there may be potential difficulties in ensuring electromagnetic compatibility in other environments.**
- **In addition to cables sold by the manufacturer of this monitor as spare parts for internal components, the use of accessories and cables other than those specified may result in increased emission or reduced immunity of this monitor.**
- **Even if other equipment meets the emission requirements of corresponding national standards, this monitor may still be interfered by other equipment.**
- **A warning that operation of the EQUIPMENT or SYSTEM below the minimum amplitude or value may cause inaccurate results. The minimum amplitude or value of patient physiological signal: the minimum amplitude of ECG signal is 0.5mV, the minimum value of PR is 30bpm and the minimum value of SpO2 is 70%.**

Table 1

Guidance and manufacture's declaration – electromagnetic emission		
The monitor is intended for use in the environment specified below. The customer or the user of the monitor should assure that it is used in such environment.		
Emission test	Compliance	Electromagnetic environment – guidance
RF emissions CISPR11	Group1	The <i>monitor</i> uses RF energy only for its internal function. Therefore, its RF emissions are very low and are not likely to cause any interference in nearby electronic equipment.
RF emission CISPR 11	Class A	The monitor is suitable for use in all establishments other than domestic and those directly connected to the public low-voltage power supply network that supplies building used for domestic purposes.
Harmonic emissions IEC 61000-3-2	Class A	
Voltage fluctuations / flicker emissions	Complies	

IEC 61000-3-3

If the system is operated within the electromagnetic environment listed in Table Guidance and Declaration – Electromagnetic Immunity, the system will remain safe and provide the following essential performance:

- ◆ **Operating mode**
- ◆ **Accuracy**
- ◆ **Function**
- ◆ **Accessories identification**
- ◆ **Date stored**
- ◆ **Alarm**
- ◆ **Detect for connection**
- ◆ **Parameter**

Table 2

Guidance and manufacture's declaration – electromagnetic immunity			
The monitor is intended for use in the electromagnetic environment specified below. The customer or the user of monitor should assure that it is used in such an environment.			
Immunity test	IEC60601 test level	Compliance level	Electromagnetic environment – guidance
Electrostatic discharge (ESD) IEC 61000-4-2	±8 kV contact ±15 kV air	±8 kV contact ±15 kV air	Floors should be wood, concrete or ceramic tile. If floors are covered with synthetic material, the relative humidity should be at least 30%.
Electrical fast transient/burst IEC 61000-4-4	±2 kV for power supply lines ±1 kV for input/output lines	±2kV for power supply lines ±1 kV for input/output lines	Mains power quality should be that of a typical commercial or hospital environment.
Surge IEC 61000-4-5	±1 kV line(s) to line(s) ±2 kV line(s) to earth	±1 kV line(s) to line(s) ±2 kV line(s) to earth	

<p>Voltage dips, short interruptions and voltage variations on power supply input lines IEC 61000-4-11</p>	<p>0 % UT; 0.5 cycle At 0°, 45°, 90°, 135°, 180°, 225°, 270°and 315° 0 % UT; 1 cycle and 70 % UT; 25/30 cycles Single phase: at 0° 0 % UT; 250/300 cycles</p>	<p>0 % UT; 0.5 cycle At 0°, 45°, 90°, 135°, 180°, 225°, 270°and 315° 0 % UT; 1 cycle and 70 % UT; 25/30 cycles Single phase: at 0° 0 % UT; 250/300 cycles</p>	<p>Mains power quality should be that of a typical commercial or hospital environment. If the user of the monitor requires continued operation during power mains interruptions, it is recommended that the monitor be powered from an uninterruptible power supply or a battery.</p>
<p>Power frequency (50/60 Hz) magnetic field IEC 61000-4-8</p>	<p>30A/m</p>	<p>30A/m</p>	<p>Power frequency magnetic fields should be at levels characteristic of a typical location in a typical commercial or hospital environment.</p>
<p>NOTE: UT is the a.c. mains voltage prior to application of the test level.</p>			

Table 3

<p>Guidance and manufacture's declaration – electromagnetic immunity</p>			
<p>The monitor is intended for use in the electromagnetic environment specified below. The customer or the user of monitor should assure that it is used in such an environment.</p>			
<p>Immunity test</p>	<p>IEC 60601 test level</p>	<p>Compliance level</p>	<p>Electromagnetic environment – guidance</p>
<p>Conducted RF IEC 61000-4-6</p>	<p>3Vrms 150kHz~ 80MHz</p>	<p>3Vrms</p>	<p>Portable and mobile RF communications equipment should be used no closer to any part of the <i>monitor</i> including cables,</p>

<p>Radiated RF IEC 61000-4-3</p>	<p>3V/m 80MHz~ 2.7GHz</p>	<p>3V/m</p>	<p>than the recommended separation distance calculated from the equation applicable to the frequency of the transmitter.</p> <p>Recommended separation distance:</p> $d = \left[\frac{3.5}{V_1} \right] \sqrt{P} \quad 150 \text{ KHz to } 80 \text{ MHz}$ $d = \left[\frac{3.5}{E_1} \right] \sqrt{P} \quad 80 \text{ MHz} \sim 800 \text{ MHz}$ $d = \left[\frac{7}{E_1} \right] \sqrt{P} \quad 80 \text{ MHz} \sim 2.7 \text{ GHz}$ <p>Where P is the maximum output power rating of the transmitter in watts (W) according to the transmitter manufacturer and d is the recommended separation distance in metres (m).</p> <p>Field strengths from fixed RF transmitters, as determined by an electromagnetic site survey,^a should be less than the compliance level in each frequency range.^b</p> <p>Interference may occur in the vicinity of equipment marked with the following symbol:</p> 
<p>NOTE 1 At 80 MHz and 800 MHz, the higher frequency range applies.</p> <p>NOTE 2 These guidelines may not apply in all situations. Electromagnetic propagation is affected by absorption and reflection from structures, objects and people.</p> <p>Note 3: The device that intentionally receives RF electromagnetic energy at the exclusion band (2400-2483.5MHz) is exempt from the ESSENTIAL PERFORMANCE requirements, but remains safe.</p>			

- ^a Field strengths from fixed RF transmitters, such as base stations for radio (cellular/cordless) telephones and land mobile radios, amateur radio, AM and FM radio broadcast and TV broadcast cannot be predicted theoretically with accuracy. To assess the electromagnetic environment due to fixed RF transmitters, an electromagnetic site survey should be considered. If the measured field strength in the location in which the monitor is used exceeds the applicable RF compliance level above, the monitor should be observed to verify normal operation. If abnormal performance is observed, additional measures may be necessary, such as re-orienting or relocating the monitor.
- ^b Over the frequency range 0.15 MHz to 80 MHz, field strengths should be less than 3 V/m.

Table 4

Recommended separation distances between portable and mobile RF communications equipment and the monitor			
The monitor is intended for use in an electromagnetic environment in which radiated RF disturbances are controlled. The customer or the user of the monitor can help prevent electromagnetic interference by maintaining a minimum distance between portable and mobile RF communications equipment (transmitters) and the monitor.			
Rated maximum output power of transmitter (w)	Separation distance according to frequency of transmitter		
	150kHz~80MHz $d = 1.2\sqrt{P}$	80MHz~800MHz $d = 1.2\sqrt{P}$	80 MHz~2.7 GHz $d = 2.3\sqrt{P}$
0.01	0.12	0.12	0.23
0.1	0.38	0.38	0.73
1	1.20	1.20	2.30
10	3.80	3.80	7.30
100	12.00	12.00	23.00
For transmitters rated at a maximum output power not listed above, the recommended separation distance d in metres (m) can be estimated using the equation applicable to the frequency of the transmitter, where P is the maximum output power rating of the transmitter in watts (W) according to the transmitter manufacturer.			
NOTE 1 At 80 MHz and 800 MHz, the separation distance for the higher frequency range applies.			
NOTE 2 These guidelines may not apply in all situations. Electromagnetic propagation is affected by absorption and reflection from structures, objects and people.			

B.2 The management compliance of Radio

RF Parameter

Radio frequency transmitter	Operating frequency	Modulation	Transmission power
WiFi IEEE802.11a/b/g/n	2.4GHz~2.495GHz 5.15 GHz~5.35GHz 5.47 GHz~5.725GHz 5.725 GHz~5.82GHz	DSSS and OFDM	<20dBm (average value) <30dBm (Peak)

The radio module used in the device is complied with the essential requirements and other relevant provisions of The Radio Equipment Directive.



WARNING:

- **Keep a distance of at least 20 cm away from the monitor when WIFI function is in use.**

Appendix C Default Settings

This chapter lists some important factory default settings for monitors. The user cannot change the factory default settings, but the monitor can be restored to the factory default settings when necessary.

C.1 ECG, Arrhythmia, ST, QT

C.1.1 ECG

Item		Default Setting
HR	Alarm switch	ON
	Alarm high limit	200 bpm
	Alarm low limit	100 bpm
	Alarm priority	Med
	Alarm output	Off
	Alarm source	HR
ECG 1		II
ECG2 (5-lead, 6-lead, 12-lead)		I
ECG Gain		×1
Waveform Speed		25 mm/s
Filter Mode		Monitor
Notch Filter		On
Lead type		3-lead
QRS volume		3
Paced		Unspecified
Pacer Reject		Off

C.1.2 Arrhythmia

Item	Alarm switch	Alarm priority	Alarm output
Asystole	ON	HIGH	OFF
Vent Fib/Tach	ON	HIGH	OFF

Item	Alarm switch	Alarm priority	Alarm output
V-Tach	ON	HIGH	OFF
Vent Brady	ON	HIGH	OFF
Extreme Tachy	ON	HIGH	OFF
Extreme Brady	ON	HIGH	OFF
R on T	OFF	MED	OFF
Tachy	OFF	MED	OFF
Brady	OFF	MED	OFF
Nonsustained V-Tach	OFF	MED	OFF
Vent Rhythm	OFF	MED	OFF
PNC	OFF	MED	OFF
PNP	OFF	MED	OFF
Pause	OFF	MED	OFF
Pauses/min High	OFF	MED	OFF
Run PVCs	OFF	MED	OFF
Couplet	OFF	LOW	OFF
Bigeminy	OFF	LOW	OFF
Trigeminy	OFF	LOW	OFF
Frequent PVCs	OFF	LOW	OFF
PVC	OFF	LOW	OFF
Missed Beat	OFF	LOW	OFF
A-Fib	OFF	LOW	OFF
A-Fib End	OFF	LOW	OFF
ECG Noise	OFF	LOW	OFF
Irregular Rhythm	OFF	LOW	OFF
Irregular Rhythm End	OFF	LOW	OFF

C.1.3 ST

Item			Default Setting
ST-I,	ST-II,	Alarm switch	ON

Item		Default Setting
ST-III, ST-aVR, ST-aVL, ST-aVF, ST-V1, ST-V2, ST-V3, ST-V4, ST-V5, ST-V6, ST-Va, ST-Vb	Alarm high limit	0.2 mV
	Alarm low limit	-0.2 mV
	Alarm priority	MED
	Alarm output	OFF
ST analysis		OFF
ST marking line		OFF
ST point automatic adjustment		OFF
ST Point		J + 60 ms
ISO Point		-80 ms
J Point		48 ms

C.1.4 QT

Item		Default Setting
QTc	Alarm switch	OFF
	Alarm high limit	Big animal:500 Small animal:460
	Alarm priority	MED
	Alarm output	OFF
ΔQTc	Alarm switch	OFF
	Alarm high limit	60
	Alarm priority	MED
	Alarm output	OFF
QT analysis		OFF

C.2 RESP

Item		Default Setting
RR	Alarm switch	ON
	High limit	100
	Low limit	30
	Alarm priority	MED
	Alarm output	OFF
Apnea	Alarm switch	ON
	Alarm priority	HIGH, unadjustable
	Alarm output	OFF
Apnea Delay		20 s
RR Source		Auto
Resp Lead		RA_LL
Gain		×1
Waveform Speed		6.25 mm/s
Auto Threshold Detection		ON
Respiratory anti-drift		ON

C.3 SpO2

Item		Default Setting
SpO2	Alarm switch	ON
	High limit	95%
	Low limit	90%
	Alarm priority	MED
	Alarm output	OFF
Desat	Alarm switch	ON
	Low limit	80%
	Alarm priority	HIGH
	Alarm output	OFF

Item		Default Setting
NIBP Simul		OFF
Sensitivity		MED
Display PI		ON
Waveform Speed		25 mm/s
PR	Alarm switch	ON
	High limit	200 bpm
	Low limit	100 bpm
	Alarm priority	MED
	Alarm output	OFF
	Alarm source	HR
	PR source	Auto
	QRS volume	3
Tone modulation		ON

C.4 TEMP

Item		Default Setting
T1, T2	Alarm switch	ON
	High limit	38.0 °C
	Low limit	35.0 °C
	Alarm priority	MED
	Alarm output	OFF
ΔT	Alarm switch	ON
	High limit	2.0 °C
	Alarm priority	MED
	Alarm output	OFF
Unit		°C

C.5 NIBP

Item		Default Setting
NIBP-S	Alarm switch	ON
	High limit	Big animal: 160 mmHg Small animal: 90 mmHg
	Low limit	Big animal: 90 mmHg Small animal: 40 mmHg
	Alarm priority	MED
	Alarm output	OFF
NIBP-D	Alarm switch	ON
	High limit	Big animal: 90 mmHg Small animal: 60 mmHg
	Low limit	Big animal: 50 mmHg Small animal : 20 mmHg
	Alarm priority	MED
	Alarm output	OFF
NIBP-M	Alarm switch	ON
	High limit	Big animal: 110 mmHg Small animal: 70 mmHg
	Low limit	Big animal: 60 mmHg Small animal: 25 mmHg
	Alarm priority	MED
	Alarm output	OFF
NIBP-sdp	Alarm switch	ON
	High limit	60mmHg
	Low limit	20mmHg
	Alarm priority	MED
	Alarm output	OFF
Initial pressure		160 mmHg
Interval		manual
Start Mode		Clock

Item	Default Setting
NIBP End tone	OFF
Auxiliary venipuncture pressure	Big animal: 80mmHg Small animal: 40mmHg
Unit	mmHg

C.6 IBP

Item		Default Setting
IBP-S	Alarm switch	ON
	High limit	ART/Ao/UAP/BAP/FAP/LV/P1/P2 arterial pressure: 90 mmHg PA/PAWP: 60mmHg
	Low limit	ART/Ao/UAP/BAP/FAP/LV/P1/P2 arterial pressure: 55 mmHg PA/PAWP: 24 mmHg
	Alarm priority	MED
	Alarm output	OFF
IBP-D	Alarm switch	ON
	High limit	ART/Ao/UAP/BAP/FAP/LV/P1/P2 arterial pressure: 60mmHg PA/PAWP: 4 mmHg
	Low limit	ART/Ao/UAP/BAP/FAP/LV/P1/P2 arterial pressure: 20 mmHg PA/PAWP: -4 mmHg
	Alarm priority	MED
	Alarm output	OFF
IBP-M	Alarm switch	ON
	High limit	ART/Ao/UAP/BAP/FAP/LV/P1/P2 arterial pressure: 70 mmHg PA/PAWP: 26 mmHg CVP/ICP/RAP/LAP/UVP Venous pressure: 4 mmHg

Item		Default Setting
	Low limit	ART/Ao/UAP/BAP/FAP/LV/P1/P2 arterial pressure: 35 mmHg PA/PAWP: 12 mmHg CVP/ICP/RAP/LAP/UVS venous pressure: 0 mmHg
	Alarm priority	MED
	Alarm output	OFF
CPP	Alarm switch	ON
	High limit	90 mmHg
	Low limit	30 mmHg
	Alarm priority	MED
	Alarm output	OFF
Unit		ART/Ao/UAP/BAP/FAP/LV/RAP/LAP/UVS/PA/PAWP/P1/P2: mmHg CVP /ICP/ CPP: cmH2O
Sensitivity		MED
Waveform Speed		25 mm/s
Scale type		Manual
Scale	Upper scale	ART /Ao/UAP/BAP/FAP/LV/P1/P2 arterial pressure: 160mmHg CVP /ICP/RAP/LAP/UVS venous pressure : 20mmHg; PA/PAWP: 30mmHg
	Lower scale	0mmHg
High-precision cursor switch		OFF
High-precision cursor		ART/ Ao/ UAP/BAP/FAP/LV/P1/P2 arterial pressure: 80mmHg CVP /ICP/RAP/LAP/UVS venous pressure: 10mmHg PA/PAWP: 15mmHg
PPV measurement		OFF
PPV source		Auto

Item		Default Setting
Waveform overlay setup	Left scale	0~160mmHg
	Right scale	P1/P2: 0~160mmHg CVP/RAP/LAP/ICP/UVP: 0 ~20 mmHg
	Waveform speed	25 mm/s
	Gridlines	OFF

C.7 C.O.

Item		Default Setting
TB	Alarm switch	ON
	High limit	39.0 °C
	Low limit	36.0 °C
	Alarm priority	MED
	Alarm output	OFF
Measurement mode		Single
TI source		Manual
Injection volume		10cc
Catheter coefficient		0.564
Temperature Unit		°C

C.8 CO2

Item		Default Setting
Et CO2	Alarm switch	ON
	High limit	45 mmHg
	Low limit	30mmHg
	Alarm priority	MED
	Alarm output	OFF
FiCO2	Alarm switch	ON
	High limit	4 mmHg

Item		Default Setting
	Alarm priority	MED
	Alarm output	OFF
Apnea delay		20s
Waveform Speed		6.25 mm/s
Scale		50 mmHg
Waveform type		Draw
Operating Mode		Measurement mode
Unit		mmHg
Gas temperature		35 °C
Atmospheric		760mmHg
O2 compensation		16%
N2O compensation		0%
Zero gas		Air
Anesthetics		0%
Balance Gas		Air

C.9 DM

Item	Default Setting
Unit	Drops/min
Drops/mL	20

C.10 Alarm Default Settings

Item	Default Setting
Alarm Volume	2
High Priority Alarm Volume	Alarm volume + 2
Reminder Volume	5
Apnea Delay	20s

Item	Default Setting
Alarm Record Duration	8s

C.11 Screen Setup

Item	Default Setting
Screen Select	Standard screen
Screen Lock Duration	2min
Brightness	5
Brightness On Battery	1

C.12 Color of parameters

Item	Default Setting
ECG	Green
NIBP	White
SpO ₂	Yellow
TEMP	Purple
RESP	Cyan
CO ₂	White
DM	Yellow-green
IBP	Red
C.O.	White

C.13 Recorder

Item	Default Setting
Waveform 1	II
Waveform 2	Pleth
Waveform 3	RR
Record Speed	25mm/s
Record Duration	8s
Cycle Record Interval	OFF

Item	Default Setting
Cycle Record Duration	8s
Alarm Record Duration	8s
NIBP trigger	OFF

C.14 Other

Item	Default Setting	
Keypad tone	ON	
Night Mode	Brightness	1
	Alarm volume	2
	QRS volume	1
	Touch Tone	OFF
	NIBP End Tone	OFF

C.15 Maintenance Item

Item	Default Setting
Network Type	LAN
LAN IP	Use the following IP address
Frequency	2.4G
Device No.	8
Alarm Pause Duration	2min
Minimum alarm volume	2
Alarm sound	ISO
High Alarm Interval (s)	10
Medium Alarm Interval (s)	20
Low Alarm Interval (s)	20
Reset Remote Bed's Alarm	OFF
Alarm Reset By Other Bed	OFF
Alarm Off	ON
Reminder Interval	5min

Item		Default Setting
ECG Lead Off Alarm Level		MED
Alarm delay		OFF
Notch filter		50 Hz
Nurse call	Signal type	Pulse
	Trigger method	N.O.
	Alarm level	All
	Alarm type	Technical Alarm & Physiological Alarm

Appendix D Alarm Message

This chapter lists some of the most important physiological and technical alarm information, and some alarm information may not be listed.

D.1 Physiological alarm

D.1.1 General physiological alarm

Alarm messages	Default priority	Cause and solution
XX High	MED	The measured value of the corresponding parameter is higher than the alarm high limit. Please check the patient's physiological condition and confirm whether the patient type and alarm limit settings are applicable to the patient.
XX Low	MED	The measured value of the corresponding parameter is lower than the alarm high limit. Please check the patient's physiological condition and confirm whether the patient type and alarm limit settings are applicable to the patient.

Note: XX represents the nominal name of physiological parameter, such as HR, ST, RR, SpO₂ or PR, etc.

D.1.2 Arrhythmia alarm information

Alarm messages	Default priority	Alarm messages	Default priority
Asystole	HIGH	Pauses/min High	MED
Vent Fib/Tach	HIGH	Run PVCs	MED
V-Tach	HIGH	Couplet	LOW
Vent Brady	HIGH	Bigeminy	LOW
Extreme Tachy	HIGH	Trigeminy	LOW
Extreme Brady	HIGH	Frequent PVCs	LOW
R on T	MED	PVC	LOW

Alarm messages	Default priority	Alarm messages	Default priority
Tachy	MED	Missed Beat	LOW
Brady	MED	A-Fib	LOW
Nonsustained V-Tach	MED	A-Fib End	LOW
Vent Rhythm	MED	ECG Noise	LOW
PNC	MED	Irregular Rhythm	LOW
PNP	MED	Irregular Rhythm End	LOW
Pause	MED		

D.1.3 RESP Physiological Alarm

Alarm messages	Default priority	Cause and solution
RESP Apnea	High	The patient is not breathing or the respiratory signal is too weak to measure the respiratory rate. Please check the patient's condition, check whether the electrode plate is placed correctly and whether the connection of electrode plate, cable and lead wire is firm.
RESP Artifact	High	The patient's heartbeat interferes with breathing, thus making it impossible to measure the breathing rate correctly. Please check the patient's condition and check the connection of electrode plates, cables and lead wires.

D.1.4 SpO2 Physiological Alarm

Alarm messages	Default priority	Cause and solution
SpO2 Search Pulse Timeout	High	Can't find a pulse for a long time. Please immediately check the patient's condition. If the patient is normal condition, please replace placement position of blood oxygen

Alarm messages	Default priority	Cause and solution
		probe.
SpO2 Desat	High	SpO2 measurement is below the desaturation limit. Please check the patient's status and confirm whether the alarm limit setting is applicable to the patient.

D.1.5 CO2 Physiological Alarm

Alarm messages	Default priority	Cause and solution
CO2 Apnea	High	The patient is not breathing or the respiratory signal is too weak to measure the respiratory rate. Check the patient's condition and whether the air circuit connection is correct.

D.2 Technical Alarm

This chapter lists the main technical alarms, the level of technical alarms, the cleared status of alarm reset alarm prompts, and the measures to be taken after the alarm occurs. Some alarm messages may not be listed.

After different technical alarm is reset, the alarm prompt will be cleared to different degrees. The following three types of technical alarms are given in this section according to the status of alarm being cleared.

- Completely clear: the technical alarm is completely clear. The monitor has no alarm indication.
- Sound and light can be cleared: the technical alarm displays as prompt information.
- Not clearable: the sound of technical alarm is shielded.

D.2.1 General technical alarm

Alarm messages	Default priority	Alarm clear method	Cause and solution
XX Communication error	Med	Not clearable	XX measurement module failure or communication failure.

Note: "XX" represents the module name, such as ECG, SpO2, IBP, TEMP, etc.

D.2.2 ECG Technical Alarm

Alarm messages	Default priority	Alarm clear method	Cause and solution
ECG Self-test Error	Med	Not clearable	Board failure. Please contact the manufacturer for repair.
ECG Leads Off	Med	Sound and light can be cleared	All ECG leads fall off or ECG cables are not connected. Please check the connection of ECG electrode plates, lead wires and cables.
ECG XX Off	Med	Sound and light can be cleared	The electrode is not firmly connected with the patient or falls off, causing the corresponding ECG lead to fall off. Please check the connection of ECG electrode plates, lead wires and cables.
ECG YY Polarized	Low	Sound and light can be cleared	ECG electrode polarization or poor contact. Please check the connection of ECG electrodes plates.
ECG Learning	Prompt	/	Relearn is triggered manually or automatically
ECG Cable Incompatible	Med	Not clearable	Use non-factory cables. Please replace the original cable.
ECG Cable Has Expired	Med	Not clearable	ECG cable has expired. Please replace the cable.

Alarm messages	Default priority	Alarm clear method	Cause and solution
ECG Cable will expire soon	Prompt	/	ECG cable is about to expire. Please replace the cable in time.
ECG Suspected Pacing Signal	Prompt	/	Pacing signal has been detected by non-pacing patients. Please check whether the patients have pacemakers and check the connection of ECG electrode sheets.
Note: XX represents RA, LA, LL, RL, V1, V2, V3, V4, V5, V6, YY represents I, II, III, aVR, aVL, aVF, V1, V2, V3, V4, V5 or V6.			

D.2.3 RESP Technical Alarm

Alarm messages	Default priority	Alarm clear method	Cause and solution
RESP Leads Off	Med	Completely clear	ECG lead-off or the ECG cable is not connected. Check the communication of ECG electrode and lead wires.

D.2.4 SpO2 Technical Alarm

Alarm messages	Default priority	Alarm clear method	Cause and solution
SpO2 Self-test Error	Med	Not clearable	Board failure. Please contact the manufacturer for repair.
SpO2 Sensor Off	Med	Sound and light can be cleared	The SpO2 sensor is falled off from the patient end. Check the connection of the sensor. If the alarm still exists, replace the sensor.

SpO2 Sensor Disconnected	Low	Sound and light can be cleared	The SpO2 main cable falls off from the module end or the connection between the SpO2 sensor and the SpO2 main cable falls off. Confirm that SpO2 main cable and sensor are connected normally. If the alarm still cannot be eliminated, replace the sensor.
SpO2 Low Confidence	Low	Not clearable	PI<0.3% or signal quality <60.
SpO2 Update Timeout	Low	Not clearable	25s SpO2 measurement data not updated.
SpO2 Motion Interference	Low	Not clearable	Patients move too much, affecting measurement.
SpO2 Searching Pulse	Prompt	/	SpO2 module is searching for pulse.
SpO2 Sensor Incompatible	Med	Not clearable	Non-factory SpO2 sensor are used. Please replace the original sensor.
SpO2 Sensor Has Expired	Med	Not clearable	SpO2 sensor has expired. Please replace the sensor.
SpO2 Sensor Will Expire Soon	Prompt	/	SpO2 sensor is about to expire. Please replace the sensor in time.

D.2.5 TEMP Technical Alarm

Alarm messages	Default priority	Alarm clear method	Cause and solution
TEMP Self-test Error	Med	Not clearable	Board failure. Please contact the manufacturer for repair.
⟨TEMP label⟩ Sensor Off	Med	Completely clear	Check the connection of the sensor and reconnect the sensor.

D.2.6 NIBP Technical Alarm

Alarm messages	Default priority	Alarm clear method	Cause and solution
NIBP Self-test Error	Med	Not clearable	Board failure. Please contact the manufacturer for repair.
NIBP System Failure	Low	Not clearable	System operation failure.
NIBP Air Pressure Error	Low	Completely clear	Pressure error, unable to maintain stable cuff pressure, such as tracheal knot.
NIBP Air Leakage	Low	Completely clear	NIBP air leakage was found in the inspection. Please check the sleeve and airpipe for air leakage.
NIBP Air System Leak	Low	Completely clear	Damaged cuff, hose or joint.
NIBP Cuff Type Error	Low	Completely clear	The cuff used does not match the patient type set. Please confirm that the patient type is set correctly and select correct cuff according to the patient type. If the patient type and cuff selection are correct, please check whether the airway and airpipe are bent or blocked.
NIBP Overpressure Detected	Med	Completely clear	The pressure exceeds the specified safety limit.
NIBP Loose Cuff	Low	Completely clear	The cuff is not tight; Or the cuff is not connected. Select the correct cuff according to the patient type, place the cuff according to the manual, and connect the airpipe.
NIBP Excessive Motion	Low	Completely clear	The patient moved frequently during the measurement. Or violent movement during measurement;

Alarm messages	Default priority	Alarm clear method	Cause and solution
			Or irregular pulse rate, such as arrhythmia.
NIBP Signal Saturated	Low	Completely clear	Great movement.
NIBP Weak Signal	Low	Completely clear	The cuff is too loose or the patient's pulse is too weak. Please check the patient's condition or whether the cuff is placed correctly.
NIBP Out of Range	Low	Completely clear	The measurement range exceeds the specified upper limit.
NIBP Time Out	Low	Completely clear	Measurement time exceeds 120s. Please check the patient's condition and the connection of accessories or replace the cuff, and conduct the measurement again.
NIBP Cycle Abort	Low	Completely clear	Three consecutive measurement failures occurred during periodic measurement. Please check whether the patient's condition or cuff placement is correct.
NIBP Zero Failed	Prompt	/	At zero, the pressure is beyond the zero range or the pressure is unstable.

D.2.7 IBP Technical Alarm

Alarm messages	Default priority	Alarm clear method	Cause and solution
IBP Self-test Error	Med	Not clearable	The board is failure. Please contact the factory for repair.
XX Sensor Off	Med	Completely clear	The XX cable is off the monitor.
XX Zero Failed	Med	Not clearable	When the XX sensor is zeroed, the sensor is not connected or the

Alarm messages	Default priority	Alarm clear method	Cause and solution
			pressure is out of range or the pressure is unstable.
XX Catheter Off	HIGH	Not clearable	The catheter is pulled out from the patient. Please check the connection.
Zero Required	Prompt	/	/
Zero Succeed	Prompt	/	The IBP module is zeroing successful
Note: XX represents IBP labels, such as PA, CVP, FAP, P1, etc.			

D.2.8 C.O. Technical Alarm

Alarm messages	Default priority	Alarm clear method	Cause and solution
C.O. TB Self-test Error	Med	Not clearable	The board is failure. Please contact the factory for repair.
C.O. TI Self-test Error	Med	Not clearable	The board is failure. Please contact the factory for repair.
C.O. TB Sensor Off	Med	Completely clear	Check the sensor connection and reconnect the sensor.
C.O. T1 Sensor Off	Med	Completely clear	Check the sensor connection and reconnect the sensor.
C.O. Measure Timeout	Low	Completely clear	When measuring manually, it do not inject for sustaining 20 seconds.

D.2.9 CO2 Technical Alarm

Alarm messages	Default priority	Alarm clear method	Cause and solution
----------------	------------------	--------------------	--------------------

Alarm messages	Default priority	Alarm clear method	Cause and solution
CO2 Sensor Off	Med	Completely clear	The CO ₂ sensor is detached from the patient or monitor.
CO2 Out of Range	Low	Not clearable	The measured data of CO ₂ module is out of range and needs zero.
CO2 Zero Required	Low	Not clearable	The sensor needs zero.
CO2 Sensor Over Temp	Low	Not clearable	Check sensor.
CO2 Compensation Not Set	Low	Not clearable	The CO ₂ sensor was not initialized. Set compensation and initialize.
CO2 Sleep Mode	Prompt	/	The CO ₂ sensor is in sleep mode. Please select the measurement mode, CO ₂ can enter the working state.
CO2 Check Sampling Line	Low	Not clearable	The CO ₂ sampling tube is blocked or damaged; The sampling tube is kinked or compacted; The exhaust pipe is blocked. Check the sampling tube.
CO2 Check Adapter	Low	Not clearable	Reinstall the airway adapter.
CO2 Zero In Progress...	Prompt	/	The CO ₂ module is being zeroed.
CO2 Sensor Warm up	Prompt	/	The CO ₂ module is warming up.
CO2 Self-Test	Prompt	/	Module initialization
CO2 Sensor Faulty, E*	Low	/	Hardware or software errors, contact after-sales personnel to check maintenance.
CO2 Self-Test Error	Low	Not clearable	Hardware errors, Replace sensor,

Alarm messages	Default priority	Alarm clear method	Cause and solution
			if the problem cannot be solved, please contact the after-sales personnel to check the maintenance.
CO2 Motor Speed Error	Low	Not clearable	Check whether the sampling tube is blocked.
CO2 Factory Calibration lost	Low	Not clearable	Contact the after-sales personnel to check the maintenance.
CO2 Sampling Line Clogged	Low	Not clearable	Check sampling line.
CO2 No Sample Line	Low	Completely clear	Check sampling line.
CO2 Internal Temp.Out of Range	Low	Not clearable	Hardware error, and contact the after-sales personnel to check the maintenance.
CO2 Ambient Pressure Out of Range	Low	Not clearable	Recalibrate atmospheric pressure.
CO2 Span Calibration Command Failed	Low	Not clearable	Contact the after-sales personnel to check the maintenance.
CO2 Span Calibration in Progress...	Prompt	/	Disappear after success.
CO2 Replace Adapter	Low	Not clearable	Check adapter.
CO2 No Adapter	Low	Completely clear	Check adapter.

D.2.10 DM Technical Alarm

Alarm messages	Default priority	Alarm clear method	Cause and solution
DM Finished	Low	Completely clear	The infusion container is empty and the infusion is complete.
DM Drip Speed Abnormal	Low	Sound and light can be cleared	During infusion, the drip rate changes by more than 20%.

D.2.11 System Alarm

Alarm messages	Default priority	Alarm clear method	Cause and solution
Battery Low	High	Not clearable	Please connect AC power supply for power supply and charge the battery.
Battery Fault	Prompt	/	Please replace the battery.
Recorder No Paper	Low	Sound and light can be cleared	The recorder is not loaded with paper or the recorder door is not closed. Please check the recorder to make sure the paper is loaded or the recorder door is closed.
Recorder Not Exist	Prompt	/	The recorder module is not plugged in. please insert the recorder module.
Recorder Too Hot	Low	Not clearable	The recorder works too long. Please restart the recording task after the recorder head cools down.
CMS Disconnected	Med	Completely clear	The monitor is disconnected from the CMS. Please check the network connection.
Disk Full	Med	Not clearable	The storage space of the monitor is full. Please clear the patient related data in time.
Disk Will Be Full	Low	Sound and light can be cleared	The storage space of the monitor is almost full. Please clear the patient related data.

Appendix E Cybersecurity

This chapter mainly describes the information related to cybersecurity of the monitor.

E.1 Operating environment

- ◆ Hardware environment
 - Monitor software is only applicable to S12 Vet monitor hardware platform.
 - Screen: 12.1" LCD screens with 4:3 aspect ratio and 800*600 resolution.
 - Peripherals: nurse call module, recorder.
- ◆ Software environment
 - Main board: S12MB
 - Operating system: Linux-3.2.0 kernel + Busybox filesystem.
 - Database: sqlite-3.16.2
- ◆ Network environment
 - Apply to LAN

E.2 Network data interface

The communication interface between the monitor and the CMS is wired or wireless Ethernet, using the standard TCP/IP protocol family, and the application layer data format follows *the Central Monitoring System Network Communication Protocol* during transmission.

E.3 User access control mechanism

- a) User identification method: after entering the authorization password, you have the corresponding user type setting authority.
- b) User types: medical personnel, hospital equipment maintenance personnel, factory maintenance personnel.
- c) User authority:
 - 1) Authority of medical staff: No password. Automatically enter the monitoring interface after starting up, and can be routinely set as required.

2) Authority of hospital equipment maintenance personnel: Enter the maintenance menu by entering the hospital maintenance password, and at least have settings for language configuration, automatic clearing of NIBP results, automatic release of waveform freezing time and alarm related contents.

3) Manufacturer's authority: Enter the maintenance menu by entering the manufacturer's maintenance password. In addition to the contents that can be set by the authority of hospital equipment maintenance personnel, the manufacturer can at least set the power frequency and module configuration.

E.4 Software Environment

- ◆ The list of system software is as follows:

Software name	Version
Linux	V3.2.0

- ◆ The supporting software is as follows:

Software name	Version
Sqlit3	V3.16.2

- ◆ The list of application software is as follows:

Software name	Supplier
S12 Vet monitor software	Guangdong Biolight Meditech Co., Ltd.

Appendix F Terminology and Definitions

F.1 List of units

Abbreviation	Full name
μA	microampere
μV	microvolt
μs	microsecond
A	ampere
Ah	ampere hour
bpm	beat per minute
bps	bit per second
$^{\circ}\text{C}$	centigrade
cc	cubic centimeter
cm	centimeter
dB	decibel
DS	dyne second
$^{\circ}\text{F}$	fahrenheit
g	gram
GHz	gigahertz
GTT	gutta
h	hour
Hz	hertz
in	inch
k	kilo
kg	kilogram
kPa	kilopascal
L	litre
lb	pound
m	meter
mAh	milliampere hour
Mb	mega byte

Abbreviation	Full name
mcg	microgram
mEq	milli-equivalents
mg	milligram
min	minute
mL	milliliter
mm	millimeter
mmHg	millimetres of mercury
cmH ₂ O	centimeters of water
ms	millisecond
mV	millivolt
mW	milliwatt
MΩ	megaohm
nm	nanometer
rpm	breaths per minute
s	second
V	volt
VA	volt ampere
Ω	ohm
W	watt

F.2 Symbol list

Symbol	Explanation
—	Minus
-	Negative
%	Percent
/	Per; Divide;Or
~	To
+	Plus
=	Equal to
<	Less than

>	Greater than
≤	Less than or equal to
≥	Greater than or equal to
±	Plus or minus
×	Multiply
©	Copyright

F.3 Terminology list

Abbreviation	Full name
AAMI	Association for Advancement of Medical Instrumentation
AC	Alternating current
ACI	Acceleration index
AHA	American Heart Association
ANSI	American National Standard Institute
Ao	Aortic pressure
aVF	Left foot augmented lead
aVL	Left arm augmented lead
aVR	Right arm augmented lead
awRR	Airway respiratory rate
BP	Blood pressure
BPSK	Binary phase shift keying
BSA	Bodysurface area
BTPS	Body temperature and pressures, aturated
CCU	Cardiac (coronary) care unit
CE	Conformité Européenne
CIS	Clinical information system
CISPR	International Special Committee on Radio Interference
CMOS	Complementary metal oxide semiconductor

Abbreviation	Full name
CMS	Central monitoring system
COHb	Carboxyhemoglobin
CP	Cardiopulmonary
DC	Direct current
Dia	Diastolic
DPI	Dot per inch
DVI	Digital video interface
ECG	Electrocardiograph
EDV	End-diastolic volume
EEC	European Economic Community
EMC	Electromagnetic compatibility
EMG	Electromyograph
EMI	Electromagnetic interference
ESU	Electrosurgical unit
FCC	Federal Communication Commission
FDA	Food and Drug Administration
FPGA	Field programmable gate array
FV	Flow-volume
Hb	Hemoglobin
Hb-CO	Carbon mono-xide hemoglobin
HbO2	Oxyhemoglobin
HIS	Hospital information system
HR	Heart rate
ICU	Intensive care unit
ID	Identification
IEC	International Electrotechnical Commission
IEEE	Institute of Electrical and Electronic Engineers
IP	Internet protocol
LA	Left arm
LAP	Left atrial pressure

Abbreviation	Full name
Lat	Lateral
LCD	Liquid crystal display
LCW	Left cardiac work
LCWI	Left cardiac work index
LED	Light emitting diode
LL	Left leg
LVDS	Low voltage differential signal
MDD	Medical Device Directive
MetHb	Methemoglobin
MRI	Magnetic resonance imaging
N/A	Not applied
N2	Nitrogen
N2O	Nitrous oxide
NIBP	Noninvasive blood pressure
O2	Oxygen
OR	Operating room
oxyCRG	Oxygen cardio-respirogram
Paw	Airway pressure
PD	Photodetector
Pleth	Plethy smogram
PR	Pulse rate
PVC	Premature ventricular contraction
R	Right
RA	Right arm
RAM	Random access memory
RAP	Right atrial pressure
Rec	Record, recording
RESP	Respiration
RHb	Reduced hemoglobin
RL	Right leg

Abbreviation	Full name
RR	Respiration rate
RSBI	Rapid shallow breathing index
SaO ₂	Arterial oxygen saturation
SEF	Spectral edge frequency
SFM	Self-maintenance
SpO ₂	Arterial oxygen saturation from pulse oximetry
SQI	Signal quality index
STR	Systolic time ratio
Sync	Synchronization
Sys	Systolic pressure
Taxil	Axillary temperature
TD	Temperature difference
TEMP	Temperature
TFC	Thoracic fluid content
TFI	Thoracic fluid index
TFT	Thin-film technology
Toral	Oral temperature
TP	Total power
Trect	Rectal temperature
UPS	Uninterruptible power supply
USB	Universal serial bus
VAC	Volts alternating current
VEPT	Volume of electrically participating tissue
VI	Velocity index

Appendix G Toxic and Harmful Substances or elements

Components		Lead Pb	Mercury Hg	Cadmium Cd	Hexavalent chromium Cr(VI)	Polybrominated biphenyls PBB	Polybrominated diphenyl ethers PBDE
Host	Shell (plastic parts)	<input type="checkbox"/>	<input type="checkbox"/>	<input type="checkbox"/>	<input type="checkbox"/>	<input type="checkbox"/>	<input type="checkbox"/>
	Label	<input type="checkbox"/>	<input type="checkbox"/>	<input type="checkbox"/>	<input type="checkbox"/>	<input type="checkbox"/>	<input type="checkbox"/>
	Internal sheet metal	<input type="checkbox"/>	<input type="checkbox"/>	<input type="checkbox"/>	<input type="checkbox"/>	<input type="checkbox"/>	<input type="checkbox"/>
	EMI Gasket	<input type="checkbox"/>	<input type="checkbox"/>	<input type="checkbox"/>	<input type="checkbox"/>	<input type="checkbox"/>	<input type="checkbox"/>
	Silicone Piece	<input type="checkbox"/>	<input type="checkbox"/>	<input type="checkbox"/>	<input type="checkbox"/>	<input type="checkbox"/>	<input type="checkbox"/>
Package	Package materials	<input type="checkbox"/>	<input type="checkbox"/>	<input type="checkbox"/>	<input type="checkbox"/>	<input type="checkbox"/>	<input type="checkbox"/>
General	Adapting piece	<input type="checkbox"/>	<input type="checkbox"/>	<input type="checkbox"/>	<input type="checkbox"/>	<input type="checkbox"/>	<input type="checkbox"/>
	Power cord	<input type="checkbox"/>	<input type="checkbox"/>	<input type="checkbox"/>	<input type="checkbox"/>	<input type="checkbox"/>	<input type="checkbox"/>
Battery	Lithium battery	<input type="checkbox"/>	<input type="checkbox"/>	<input type="checkbox"/>	<input type="checkbox"/>	<input type="checkbox"/>	<input type="checkbox"/>
Accessory	ECG accessory	<input type="checkbox"/>	<input type="checkbox"/>	<input type="checkbox"/>	<input type="checkbox"/>	<input type="checkbox"/>	<input type="checkbox"/>
	SpO ₂ accessory	<input type="checkbox"/>	<input type="checkbox"/>	<input type="checkbox"/>	<input type="checkbox"/>	<input type="checkbox"/>	<input type="checkbox"/>
	TEMP accessory	<input type="checkbox"/>	<input type="checkbox"/>	<input type="checkbox"/>	<input type="checkbox"/>	<input type="checkbox"/>	<input type="checkbox"/>
	NIBP accessory	<input type="checkbox"/>	<input type="checkbox"/>	<input type="checkbox"/>	<input type="checkbox"/>	<input type="checkbox"/>	<input type="checkbox"/>

S12 Vet Monitor User's Manual

	y						
	CO ₂ accessory	○	○	○	○	○	○
Stand	Carts stand	○	○	○	○	○	○
	Wall stand	○	○	○	○	○	○
<p>○: It means that the content of the toxic and harmful substances in all homogeneous materials of the component is below the limit specified in SJ/T11363-2006.</p> <p>×: Indicates that the content of the toxic and harmful substances in at least one homogeneous material of the component exceeds the limit requirements specified in SJ/T11363-2006.</p>							

Product name: Veterinary Monitor

Product model: S12 Vet

Manufacturer: Guangdong Biolight Meditech Co., Ltd.

**Address: No.2 Innovation First Road, Technical Innovation Coast,
Hi-tech Zone, Zhuhai, P.R. China**

Fax: 0756-3399919

Post code: 519085

Toll-free consultation hot line: 400-8818-233

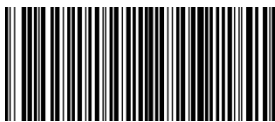

PN: 22-075-0022